

**OUTDOOR  
DECORATIVE  
LANDSCAPE  
LUMINAIRES**





SYSKA LED Lights are a smart innovation in the green lighting industry. They are products that provide a simple and lasting lighting solution to the end user. Its advanced technology, energy efficiency and its durability takes it light years ahead, giving it a clear edge in today's market. Every LED light made by SYSKA LED is crafted to meet global standards.

SYSKA LED Lights not only have the right technology, but they also perform with ease. They are developed specially to optimize their output, outshining many other lights in the market. SYSKA LED Lights are superior quality products priced fairly, offering 2 years warranty.



SYSKA LED Lights offer a wide range of **garden & decorative** LED Lights of international quality, for varied applications providing reliable, effective and energy efficient lighting.

**Applicatoins:**

Gardens, parks, farm houses, lawns, theme parks, residential, office, and many indoor & outdoor lighting applications.



[LED Post Top Lanterns](#)

---

[Page 1-4](#)



[LED Updown Light](#)

---

[Page 5-18](#)



[LED Wall Light](#)

---

[Page 19-28](#)

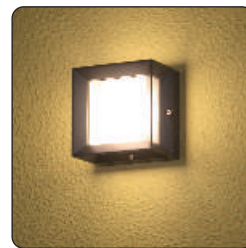

[LED Gate Light](#)

---

[Page 29-29](#)



[LED Step Light](#)

---

[Page 30-32](#)

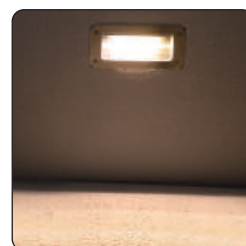

[LED Garden Light](#)

[Page 33-38](#)



[LED Bollard Light](#)

[Page 39-43](#)



[LED Burial Light](#)

[Page 44-49](#)

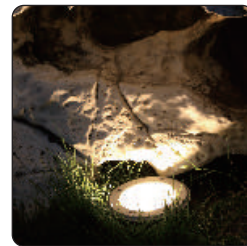

[LED Floor Light](#)

[Page 50-51](#)



[LED Fountain Light](#)

[Page 52-53](#)

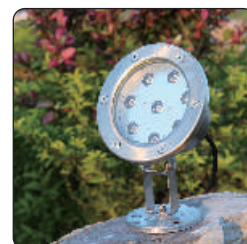



## GALAXY SERIES

### SSK-PTL-G-6002

- Power: 60W
- Lumens: 5400lm
- Ra: >70
- Working Temp: -10°C TO 50°C
- Beam angle >120°
- CCT: 3000K/6000K
- Fitting Type: Wall, Garden, Burial etc.

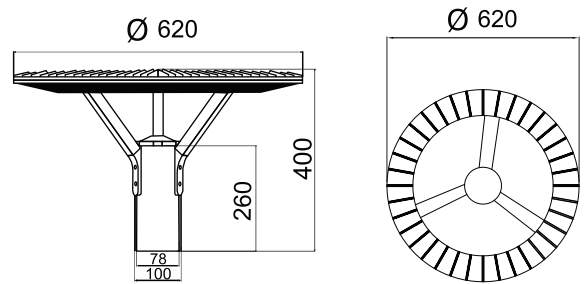

SSK-PTL-G-6002

- Die-casting aluminum lamp body;
- Frosted PC diffuser;



## GALAXY SERIES

### SSK-PTL-G-I-4003

### SSK-PTL-G-I-6003

- Power: 40W
- Lumens: 3200lm
- Ra: >70
- Working Temp: -10°C TO 50°C
- Beam angle >120°
- CCT: 3000K/6000K
- Fitting Type: Wall, Garden, Burial etc.
- Power: 60W
- Lumens: 4800lm

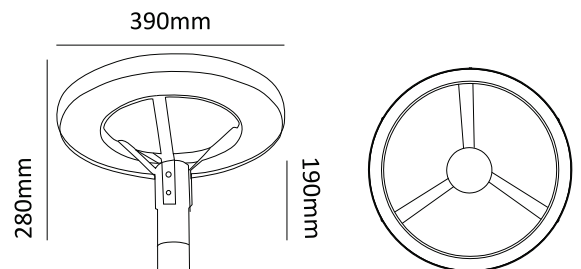

SSK-PTL-G-I-4003

SSK-PTL-G-I-6003

- Die-casting aluminum lamp body;
- Frosted PC diffuser;



# POST TOP LANTERNS



SSK-PTL-CL-4501

## CELESTIA

SSK-PTL-CL-4501

- Power: 45W
- Lumens: 4500lm
- Ra: >70
- Working Temp: -10°C TO 50°C
- Beam angle >120°
- CCT: 3000K/6000K
- Fitting Type: Wall, Garden, Burial etc.

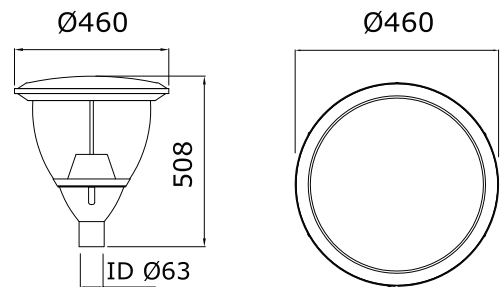

- Die-casting aluminum lamp body;
- Frosted PC diffuser;



SSK-PTL-A-4501

SSK-PTL-A-6001

## ARIANA

SSK-PTL-A-4501

SSK-PTL-A-6001

- Power: 45W
- Lumens: 3800lm
- Ra: >70
- Working Temp: -10°C TO 50°C
- Beam angle >120°
- CCT: 3000K/6000K
- Fitting Type: Wall, Garden, Burial etc.
- Power: 60W
- Lumens: 5100lm

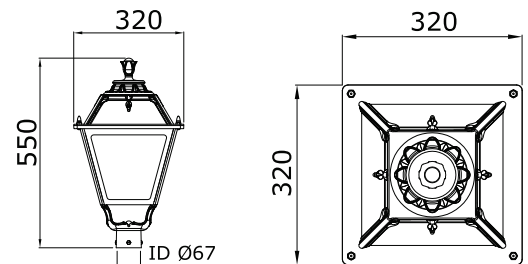

- Die-casting aluminum lamp body;
- Frosted or Clear PC diffuser;



# POST TOP LANTERNS



SSK-PTL-C-3601~6001

## COLONIAL

SSK-PTL-C-3601

- Power: 36W
- Lumens: 3600lm

SSK-PTL-C-4501

- Power: 45W
- Lumens: 4500lm

SSK-PTL-C-6001

- Power: 60W
- Lumens: 6000lm

- Ra: >70
- Working Temp: -10°C TO 50°C
- Beam angle >120°
- CCT: 3000K/6000K

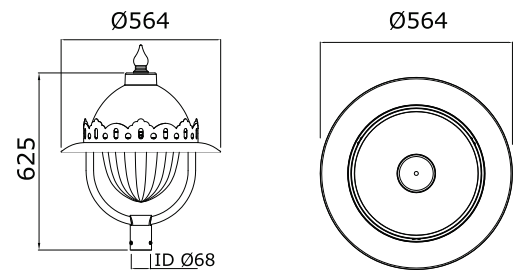

- Die-casting aluminum lamp body;
- Frosted PC diffuser;



SSK-HAL-4501~15001

## BELLBOURNE SERIES

SSK-HAL-4501~9001

- Power: 45W~90W
- Lumens @ 6500K: 100lm/W

SSK-HAL-12001~15001

- Power: 120W~150W
- Lumens @ 6500K: 100lm/W

- PF: 0.95
- Working Temp: -10°C TO 50°C
- Beam angle >90°
- CCT: 3000K/6000K
- Fitting Type: Wall, Garden, Burial etc.

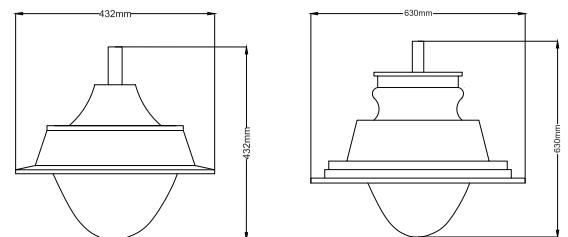

- Aluminum housing with powder coating;
- Frosted or Clear PC diffuser;







SSK-PTL-L-4001

## LOTUS

### SSK-PTL-L-4001

- Power: 40W
- Lumens: 4000lm
- Ra: >70
- Working Temp: -10°C TO 50°C
- Beam angle >120°
- CCT: 3000K/6000K
- Fitting Type: Wall, Garden, Burial etc.

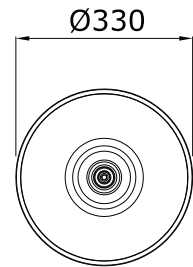
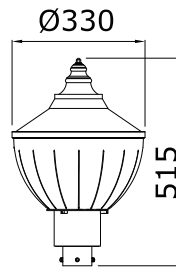

- Die-casting aluminum lamp body;
- Clear PC diffuser;



SSK-PTE-25W~60W

## YASHIP

### SSK-PTE-25W

- Power: 25W
- Lumens: 2500lm

### SSK-PTE-40W

- Power: 40W
- Lumens: 4000lm

### SSK-PTE-45W

- Power: 45W
- Lumens: 4500lm

### SSK-PTE-60W

- Power: 60W
- Lumens: 6000lm

- Ra: >70
- Working temp: -10°C to 50°C
- Beam angle >120°
- CCT: 3000K/6000K
- Fitting Type: Wall, Garden, Burial etc.

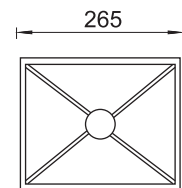
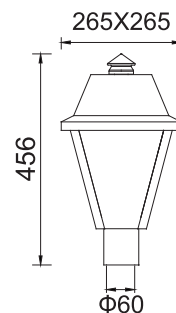

- Die-casting aluminum lamp body;





SSK-UDL-01-3011



## SSK-UDL-01-3011

- Power: LED 1\* 6W
- Lumens: 600lm
- Ra: >80
- Working Temp: -10°C TO 50°C
- Beam angle>120°
- CCT: 3000K/6000K
- Fitting Type: Wall, Garden, Burial etc.

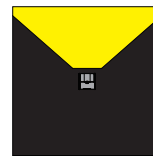
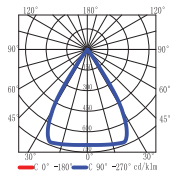
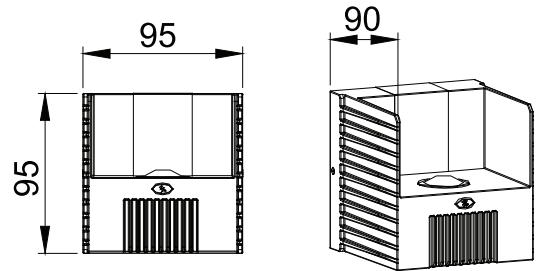

- Die-casting aluminum lamp body;
- Tempered glass diffuser;
- Silicone rubber gasket;
- Powder coating finish;



SSK-UDL-02-3012



## SSK-UDL-02-3012

- Power: LED 2\* 6W
- Lumens: 1200lm
- Ra: >80
- Working Temp: -10°C TO 50°C
- Beam angle>120°
- CCT: 3000K/6000K
- Fitting Type: Wall, Garden, Burial etc.

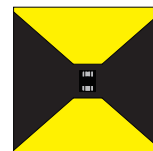
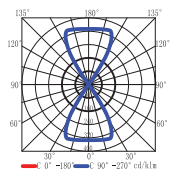
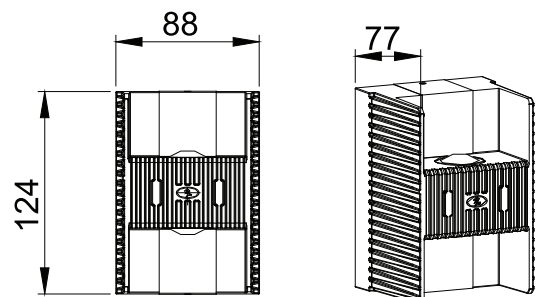

- Die-casting aluminum lamp body;
- Tempered glass diffuser;
- Silicone rubber gasket;
- Powder coating finish;



# UPDOWN LIGHT



SSK-UDL-01-3806L

## SSK-UDL-01-3806L

- Power: LED 10\* 0.5W
- Lumens: 500lm
- Ra: >80
- Working Temp: -10°C TO 50°C
- Beam angle>120°
- CCT: 3000K/6000K
- Fitting Type: Wall, Garden, Burial etc.

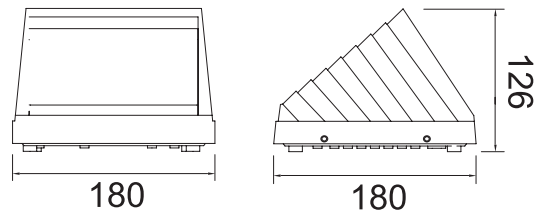

- Die-casting aluminum lamp body;
- Transparent, tempered glass diffuser;



SSK-UDL-4835

## SSK-UDL-4835

- Power: LED 2\* 3W
- Lumens: 600lm
- Ra: >80
- Working Temp: -10°C TO 50°C
- Beam angle>120°
- CCT: 3000K/6000K
- Fitting Type: Wall, Garden, Burial etc.

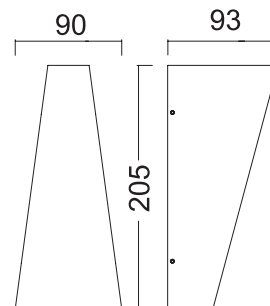

- Die-casting aluminum lamp body;
- Transparent, tempered glass diffuser;



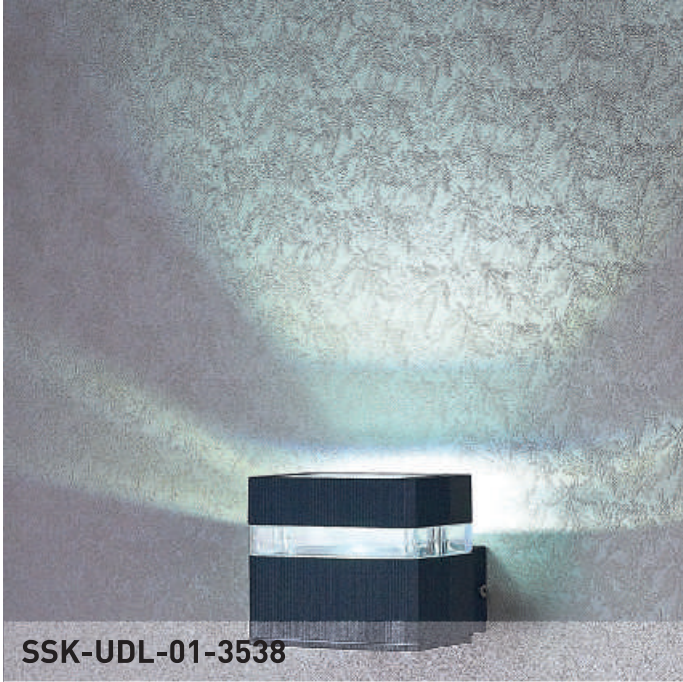

## SSK-UDL-01-3538

- Power: LED 1\* 6W
- Lumens: 600lm
- Ra: >80
- Working Temp: -10°C TO 50°C
- Beam angle>120°
- CCT: 3000K/6000K
- Fitting Type: Wall, Garden, Burial etc.

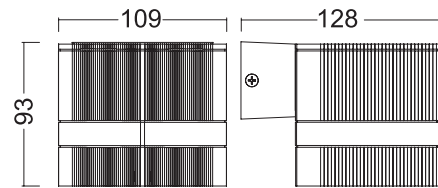

SSK-UDL-01-3538

- Die-casting aluminum lamp body;
- Opal PC diffuser;



## SSK-UDL-01-3537

- Power: LED 1\* 6W
- Lumens: 600lm
- Ra: >80
- Working Temp: -10°C TO 50°C
- Beam angle>120°
- CCT: 3000K/6000K
- Fitting Type: Wall, Garden, Burial etc.

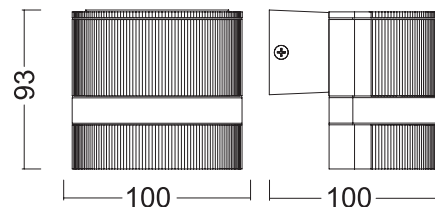

SSK-UDL-01-3537

- Die-casting aluminum lamp body;
- Opal PC diffuser;





## SSK-UDL-013000S

- Power: LED 3\* 6W
- Lumens: 300lm
- Ra: >80
- Working Temp: -10°C TO 50°C
- Beam angle>120°
- CCT: 3000K/6000K
- Fitting Type: Wall, Garden, Burial etc.

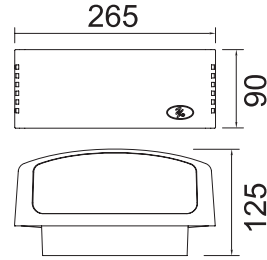

SSK-UDL-013000S



- Die-casting aluminum lamp body;
- Transparent, tempered glass diffuser;



## SSK-UDL-3000S

- Power: LED 2\* 3W
- Lumens: 600lm
- Ra: >80
- Working Temp: -10°C TO 50°C
- Beam angle>120°
- CCT: 3000K/6000K
- Fitting Type: Wall, Garden, Burial etc.

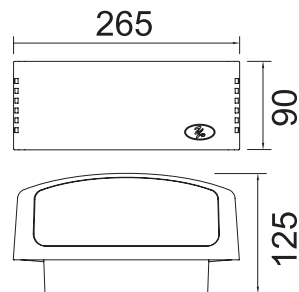

SSK-UDL-3000S



- Die-casting aluminum lamp body;
- Transparent, tempered glass diffuser;





## SSK-UDL-013051

- Power: LED 3\* 1W
- Lumens: 300lm
- Ra: >80
- Working Temp: -10°C TO 50°C
- Beam angle>120°
- CCT: 3000K/6000K
- Fitting Type: Wall, Garden, Burial etc.

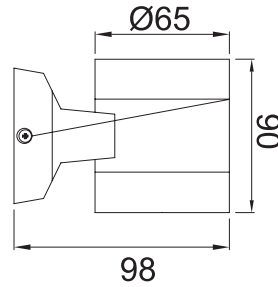

SSK-UDL-013051



- Die-casting aluminum lamp body;
- Transparent, tempered glass diffuser;
- 304 stainless steel hexagaon head screws



## SSK-UDL-013052

- Power: LED 1\* 3W
- Lumens: 300lm
- Ra: >80
- Working Temp: -10°C TO 50°C
- Beam angle>120°
- CCT: 3000K/6000K
- Fitting Type: Wall, Garden, Burial etc.
- Also available in blue color

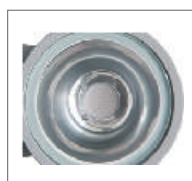

- Die-casting aluminum lamp body;
- Transparent, tempered glass diffuser;
- 304 stainless steel hexagaon head screws





SSK-UDL-01-3041



## SSK-UDL-01-3041

- Power: LED CREE-COB6W
- Lumens: 600lm
- Ra: >80
- Working Temp: -10°C TO 50°C
- Beam angle >120°
- CCT: 3000K/6000K
- Fitting Type: Wall, Garden, Burial etc.

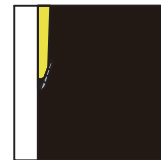
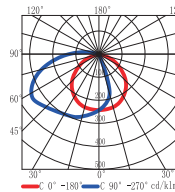
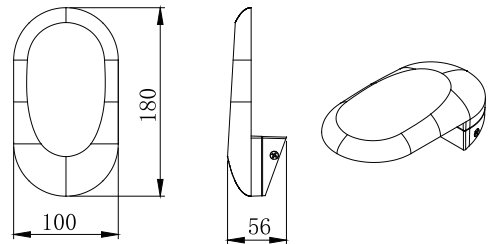

- Die-casting aluminum lamp body;
- Transparent, tempered glass diffuser;
- Silicone rubber gasket;
- Powder coating finish



SSK-UDL-01-0134

## SSK-UDL-01-0134

- Power: LED 1\*3W
- Lumens: 300lm
- Ra: >80
- Working Temp: -10°C TO 50°C
- Beam angle >120°
- CCT: 3000K/6000K
- Fitting Type: Wall, Garden, Burial etc.

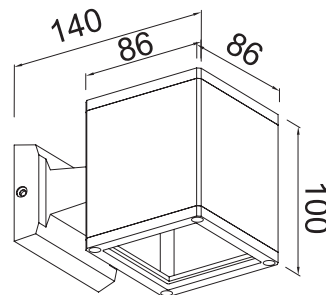

- Die-casting aluminum lamp body;
- Transparent, tempered glass diffuser;
- 304 stainless steel hexagon head screws



# UPDOWN LIGHT



SSK-UDL-01-3007



## SSK-UDL-01-3007    SSK-UDL-01-3007

- Power: LED 24\* 0.5W
- Lumens: 1200lm
- Ra: >80
- Working Temp: -10°C TO 50°C
- Beam angle>120°
- CCT: 3000K/6000K
- Fitting Type: Wall, Garden, Burial etc.

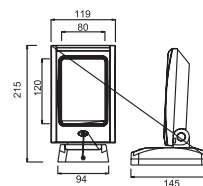

- Die-casting aluminum lamp body;
- Tempered clear glass diffuser;



SSK-UDL-01-033074-12W

## SSK-UDL-01-033074-12W

- LED CREE - COB 1\*12W
- Lumens: 1200lm
- Ra: >80
- Working Temp: -10°C TO 50°C
- Beam angle>120°
- CCT: 3000K/6000K
- Fitting Type: Wall, Garden, Burial etc.

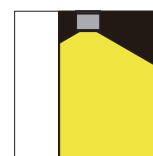
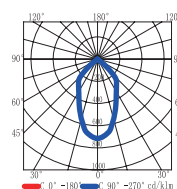
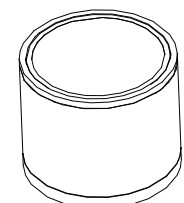
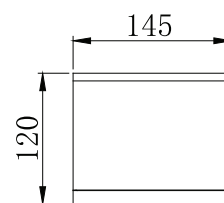

- Aluminum lamp body;
- Transparent, tempered glass diffuser;
- Silicone gasket;
- Powder coating finish;
- Anodized aluminum reflector







SSK-UDL-3035-8W

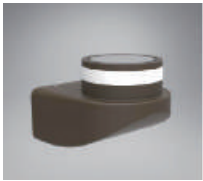

## SSK-UDL-01-3035-8W

- Power: LED CREE COB 8W
- Lumens: 800lm
- Ra: >80
- Working Temp: -10°C TO 50°C
- Beam angle>120°
- CCT: 3000K/6000K
- Fitting Type: Wall, Garden, Burial etc.

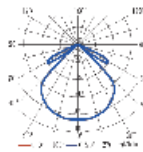
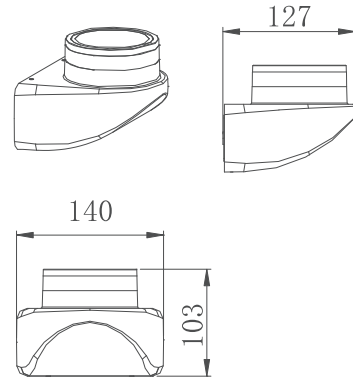

- Die-casting aluminum lamp body;
- Opal white PC diffuser;
- Silicone rubber gasket;
- Powder coating finish;



SSK-UDL-01-3037-6W

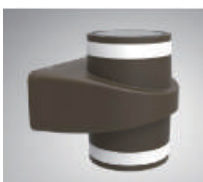

## SSK-UDL-01-3037-6W

- Power: LED CREE COB 2\*6W
- Lumens: 1200lm
- Ra: >80
- Working Temp: -10°C TO 50°C
- Beam angle>120°
- CCT: 3000K/6000K
- Fitting Type: Wall, Garden, Burial etc.

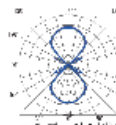
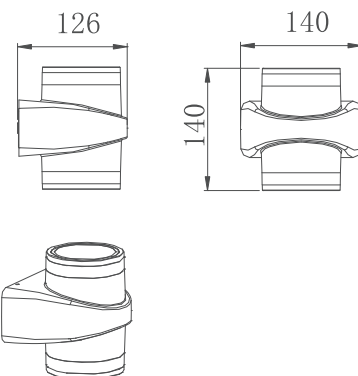

- Die-casting aluminum lamp body;
- Opal white PC diffuser;
- Silicone rubber gasket;
- Powder coating finish;





**SSK-UDL-01-3036-8W**



## SSK-UDL-01-3036

- Power: LED CREE COB 8W
- Lumens: 800lm
- Ra: >80
- Working Temp: -10°C TO 50°C
- Beam angle>120°
- CCT: 3000K/6000K
- Fitting Type: Wall, Garden, Burial etc.

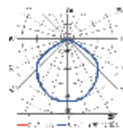
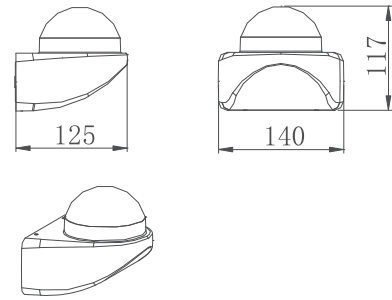

- Die-casting aluminum lamp body;
- Opal white PC diffuser;
- Silicone rubber gasket;
- Powder coating finish;



**SSK-UDL-02-3038-12W**



## SSK-UDL-02-3038-12W

- Power: LED CREE COB 2\*6W
- Lumens: 1200lm
- Ra: >80
- Working Temp: -10°C TO 50°C
- Beam angle>120°
- CCT: 3000K/6000K
- Fitting Type: Wall, Garden, Burial etc.

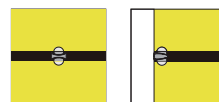
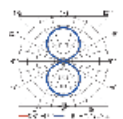
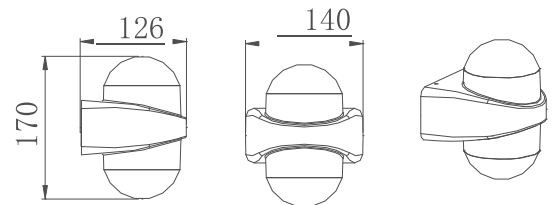

- Die-casting aluminum lamp body;
- Opal white PC diffuser;
- Silicone rubber gasket;
- Powder coating finish;



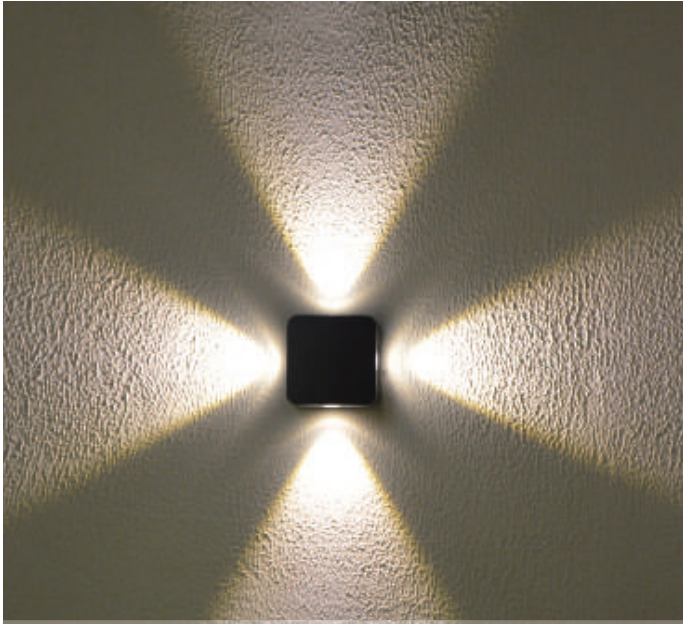

SSK-UDL-3033-4W



## SSK-UDL-3033-4W

- Power: LED 4\*1W
- Lumens: 400lm
- Ra: >80
- Working Temp: -10°C TO 50°C
- Beam angle>120°
- CCT: 3000K/6000K
- Fitting Type: Wall, Garden, Burial etc.

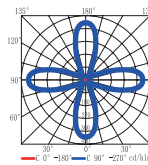
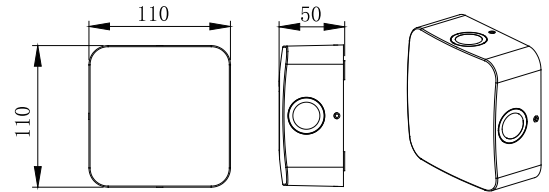

- Die-casting aluminum lamp body;
- Transparent, tempered glass diffuser;
- Silicone rubber gasket;
- Powder coating finish

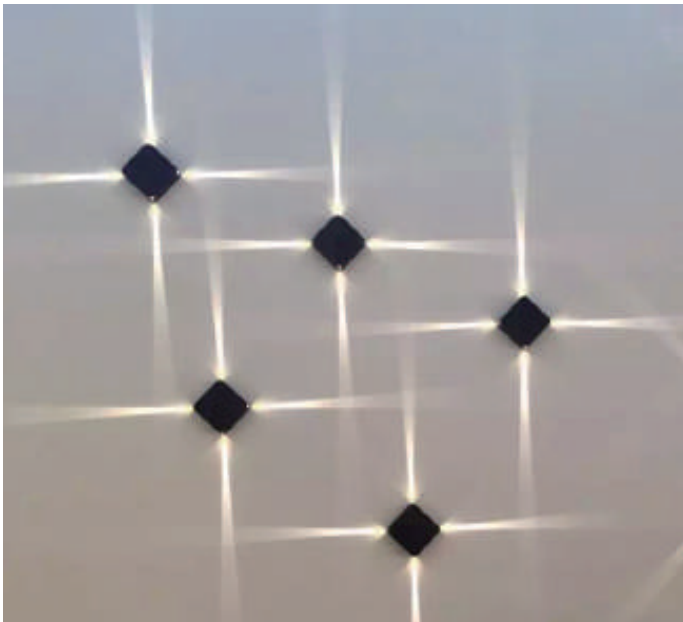

SSK-UDL-3033-4W



## SSK-UDL-3034-4W

- Power: LED 4\*1W
- Lumens: 400lm
- Ra: >80
- Working Temp: -10°C TO 50°C
- Beam angle>120°
- CCT: 3000K/6000K
- Fitting Type: Wall, Garden, Burial etc.

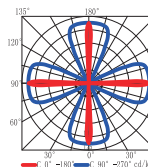
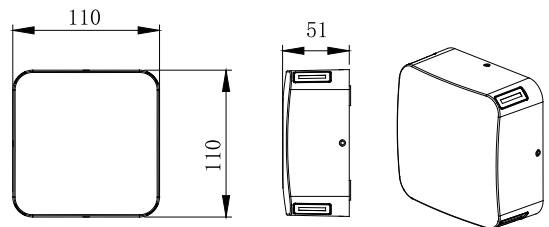

- Die-casting aluminum lamp body;
- Transparent, tempered glass diffuser;
- Silicone rubber gasket;
- Powder coating finish



# UPDOWN LIGHT

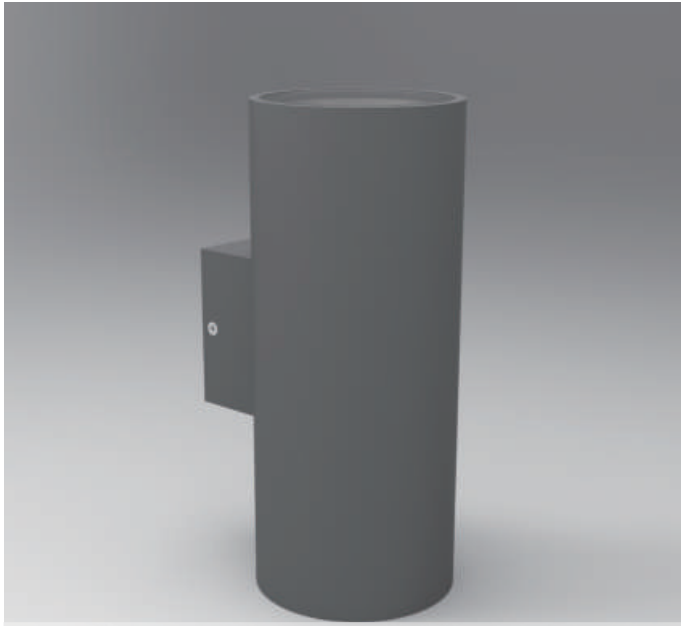

**SSK-UDL-02-003092-16W**

## SSK-UDL-02-003092-16W

- Power: LED CREE 2\*8W
- Lumens: 1600lm
- Ra: >80
- Working Temp: -10°C TO 50°C
- Beam angle>120°
- CCT: 3000K/6000K
- Fitting Type: Wall, Garden, Burial etc.

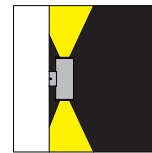
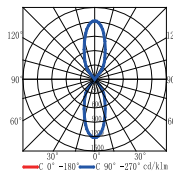
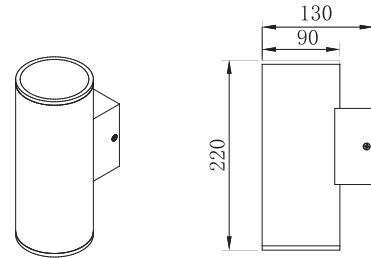

- Die-casting aluminum lamp body;
- Transparent, tempered glass diffuser;
- Silicone gasket;
- Powder coating finish;
- Anodized aluminum reflector

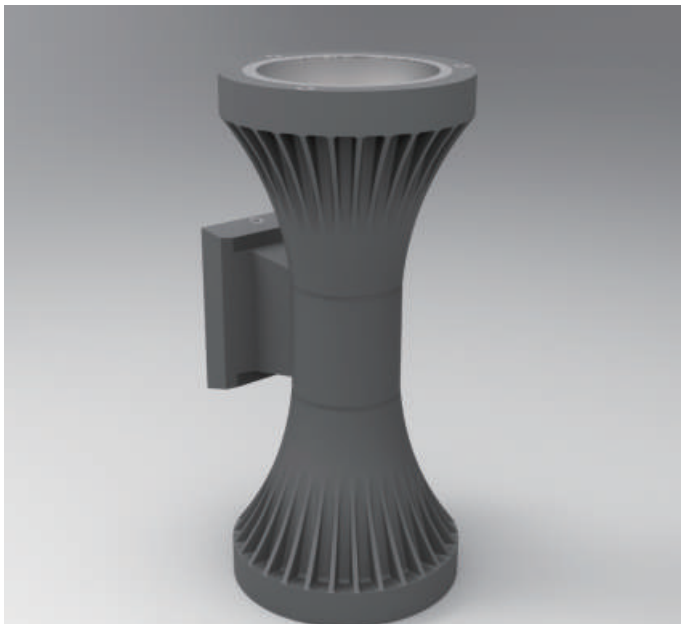

**SSK-UDL-02-013511-16W**

## SSK-UDL-02-013511-16W

- Power: LED CREE 2\*8W
- Lumens: 1600lm
- Ra: >80
- Working Temp: -10°C TO 50°C
- Beam angle>120°
- CCT: 3000K/6000K
- Fitting Type: Wall, Garden, Burial etc.

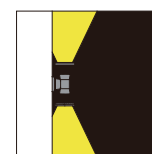
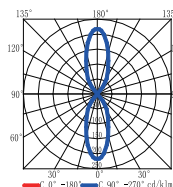
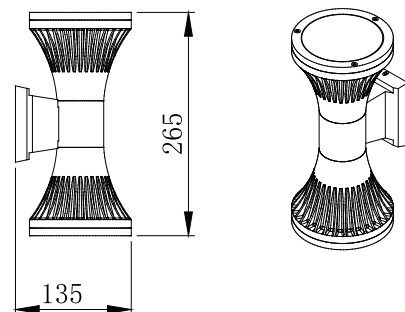

- Die-casting aluminum lamp body;
- Transparent, tempered glass diffuser;
- Silicone rubber gasket;
- Powder coating finish





**SSK-UDL-02-3471-6W**

## SSK-UDL-02-3471-6W

- Power: LED CREE 1\*6W
- Lumens: 600lm
- Ra: >80
- Working Temp: -10°C TO 50°C
- Beam angle >120°
- CCT: 3000K/6000K
- Fitting Type: Wall, Garden, Burial etc.

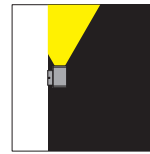
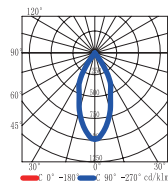
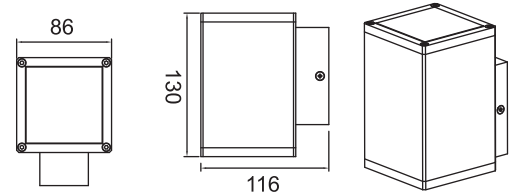

- Die-casting aluminum lamp body;
- Transparent, tempered glass diffuser;
- Silicone gasket;
- Powder coating finish;
- Anodized aluminum reflector

IP 65



**SSK-3472-12W**

## SSK-UDL-02-3472-12W

- Power: LED CREE 2\*6W
- Lumens: 1200lm
- Ra: >80
- Working Temp: -10°C TO 50°C
- Beam angle >120°
- CCT: 3000K/6000K
- Fitting Type: Wall, Garden, Burial etc.

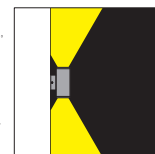
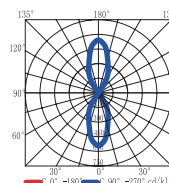
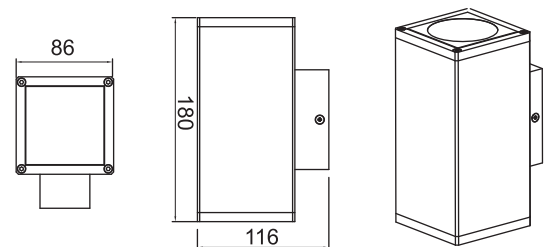

- Die-casting aluminum lamp body;
- Transparent, tempered glass diffuser;
- Silicone gasket;
- Powder coating finish;
- Anodized aluminum reflector

IP 65



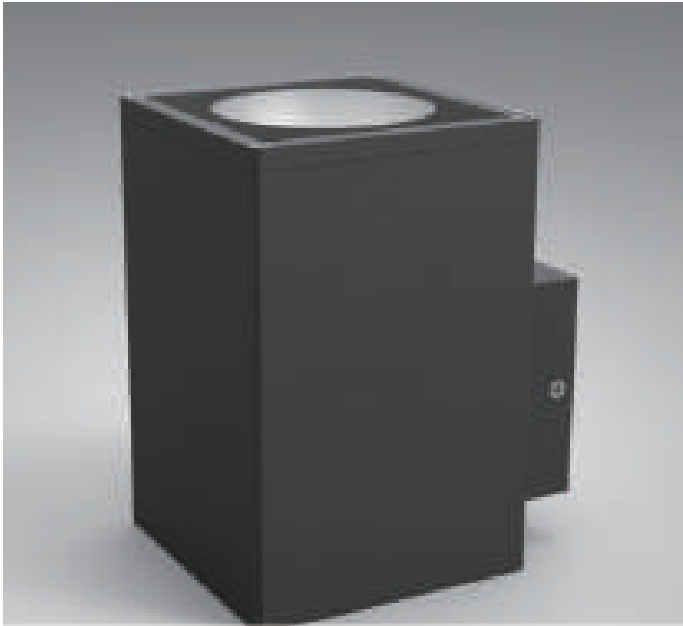

**SSK-3481-12W**

## SSK-UDL-02-3448-12W

- Power: LED CREE 1\*12W
- Lumens: 1200lm
- Ra: >80
- Working Temp: -10°C TO 50°C
- Beam angle>120°
- CCT: 3000K/6000K
- Fitting Type: Wall, Garden, Burial etc.

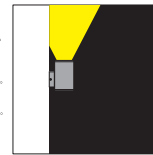
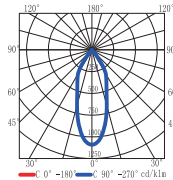
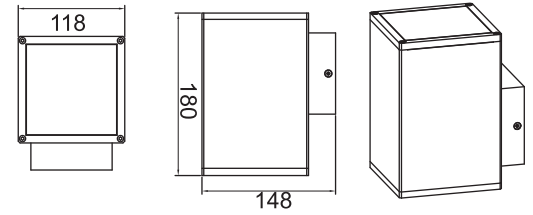

- Die-casting aluminum lamp body;
- Transparent, tempered glass diffuser;
- Silicone gasket;
- Powder coating finish;
- Anodized aluminum reflector

IP 65

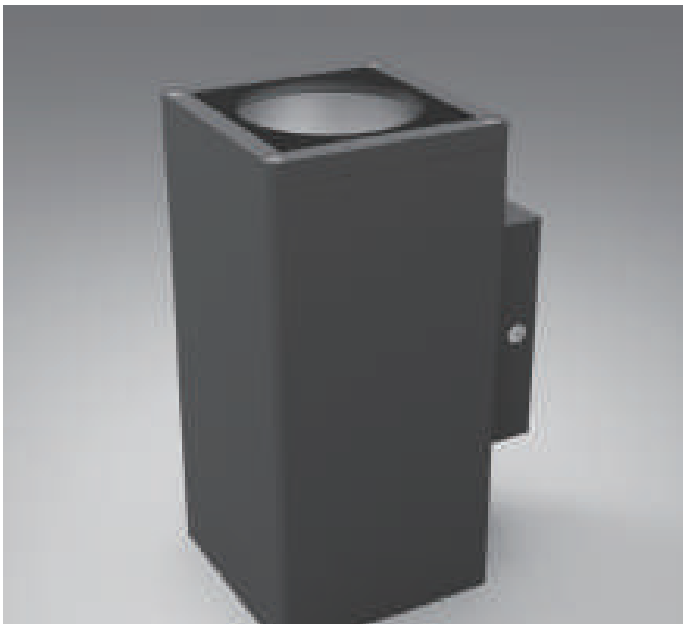

**SSK-3482-24W**

## SSK-UDL-02-3448-24W

- Power: LED CREE 2\*12W
- Lumens: 2400lm
- Ra: >80
- Working Temp: -10°C TO 50°C
- Beam angle>120°
- CCT: 3000K/6000K
- Fitting Type: Wall, Garden, Burial etc.

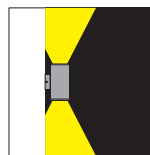
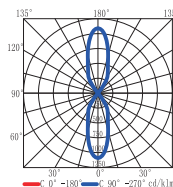
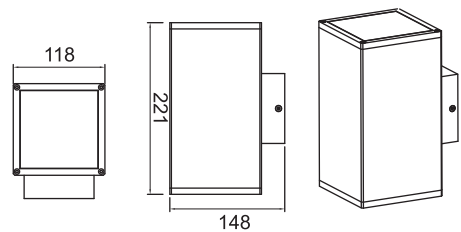

- Die-casting aluminum lamp body;
- Transparent, tempered glass diffuser;
- Silicone gasket;
- Powder coating finish;
- Anodized aluminum reflector

IP 65



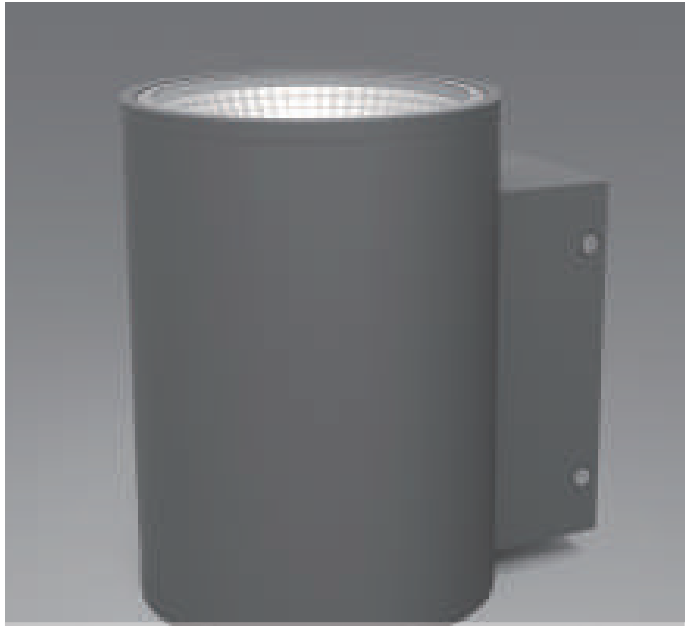

**SSK-3074-20W**

## SSK-UDL-02-3448-12W

- Power: LED CREE 1\*12W
- Lumens: 1200lm
- Ra: >80
- Working Temp: -10°C TO 50°C
- Beam angle >120°
- CCT: 3000K/6000K
- Fitting Type: Wall, Garden, Burial etc.

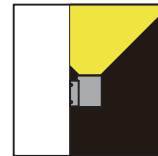
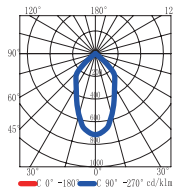
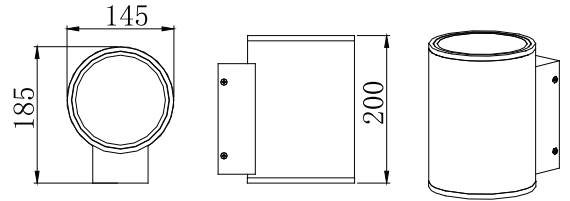

- Aluminum lamp body;
- Transparent, tempered glass diffuser;
- Silicone gasket;
- Powder coating finish;
- Anodized aluminum reflector



**SSK-3094-30W**

## SSK-UDL-02-3094-30W

- Power: LED CREE 2\*15W
- Lumens: 3000lm
- Ra: >80
- Working Temp: -10°C TO 50°C
- Beam angle >120°
- CCT: 3000K/6000K
- Fitting Type: Wall, Garden, Burial etc.

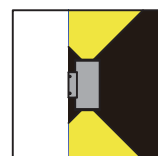
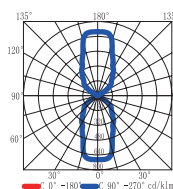
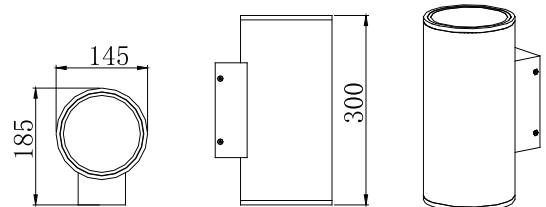

- Aluminum lamp body;
- Transparent, tempered glass diffuser;
- Silicone gasket;
- Powder coating finish;
- Anodized aluminum reflector



# WALL LIGHT



SSK-WSL-3301L-9W



SSK-WSL-3302L-9W

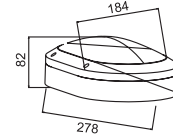

SSK-WSL-3301L

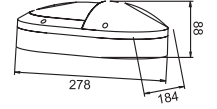

SSK-WSL-3302L

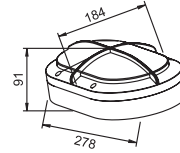

SSK-WSL-3303L

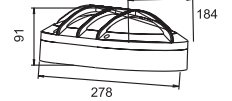

SSK-WSL-3304L



SSK-WSL-3303L-9W



SSK-WSL-3304L-9W

- Power: LED 18\*5(9W)
- Lumens: 900lm
- Ra: >80
- Working Temp: -10°C TO 50°C
- Beam angle>120°
- CCT: 3000K/6000K
- Fitting Type: Wall, Garden, Burial etc.

- Die-casting aluminum lamp body;
- Opal white PC diffuser;



SSK-WSL-3301S-5W



SSK-WSL-3302S-5W

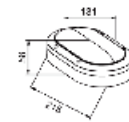

SSK-WSL-3301S

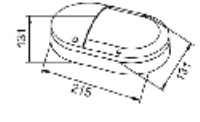

SSK-WSL-3302S

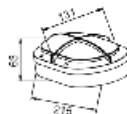

SSK-WSL-3303S

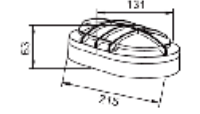

SSK-WSL-3304S

- Power: LED 10\*5 (5W)
- Lumens: 500lm
- Ra: >80
- Working Temp: -10°C TO 50°C
- Beam angle>120°
- CCT: 3000K/6000K
- Fitting Type: Wall, Garden, Burial etc.

- Die-casting aluminum lamp body;
- Opal white PC diffuser;



SSK-WSL-3303S-5W



SSK-WSL-3304S-5W



# WALL LIGHT



SSK-WSL-S-3116S-9W



SSK-WSL-S-3117S-9W



SSK-WSL-S-3118S-9W

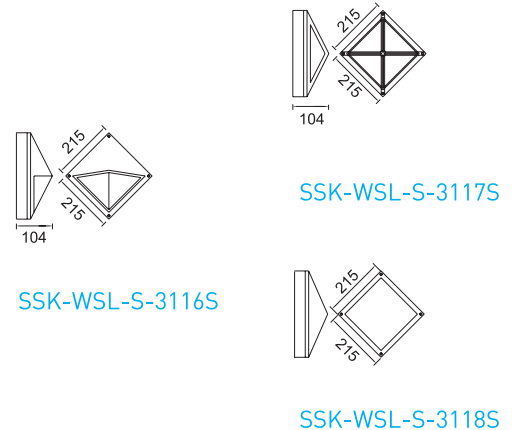

SSK-WSL-S-3116S

SSK-WSL-S-3118S

- Power: LED 18\*5(9W)
- Lumens: 900lm
- Ra: >80
- Working Temp: -10°C TO 50°C
- Beam angle>120°
- CCT: 3000K/6000K
- Fitting Type: Wall, Garden, Burial etc.

- Die-casting aluminum lamp body;
- Opal white PC diffuser;



SSK-WSL-S-3116M-15W



SSK-WSL-S-3117M-15W

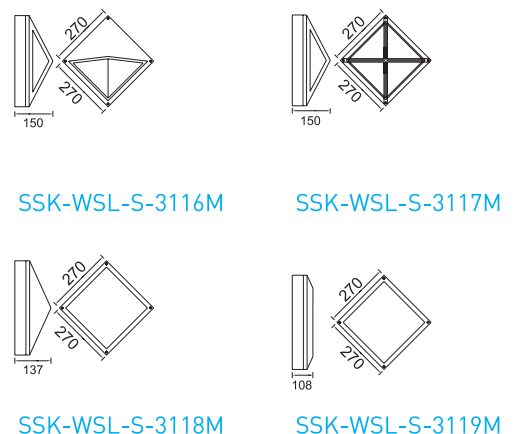

SSK-WSL-S-3116M

SSK-WSL-S-3117M

SSK-WSL-S-3118M

SSK-WSL-S-3119M



SSK-WSL-S-3118M-15W



SSK-WSL-S-3119M-15W

- Power: LED 30\*5 (15W)
- Lumens: 1500lm
- Ra: >80
- Working Temp: -10°C TO 50°C
- Beam angle>120°
- CCT: 3000K/6000K
- Fitting Type: Wall, Garden, Burial etc.

- Die-casting aluminum lamp body;
- Opal white PC diffuser;



# WALL LIGHT



SSK-WSL-C-3106L-30W



SSK-WSL-C-3107L-30W



SSK-WSL-C-3108L-30W



SSK-WSL-C-3109L-30W

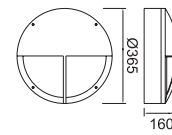

SSK-WSL-C-3106L

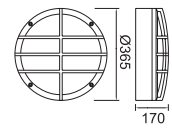

SSK-WSL-C-3107L

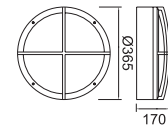

SSK-WSL-C-3108L

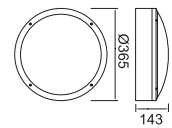

SSK-WSL-C-3109L

- Power: LED 60\*5 (30W)
- Lumens: 3000lm
- Ra: >80
- Working Temp: -10°C TO 50°C
- Beam angle>120°
- CCT: 3000K/6000K
- Fitting Type: Wall, Garden, Burial etc.



- Die-casting aluminum lamp body;
- Opal white PC diffuser;



SSK-WSL-C-3106M-18W



SSK-WSL-C-3107M-18W

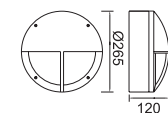

SSK-WSL-C-3106M

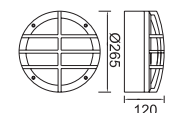

SSK-WSL-C-3107M

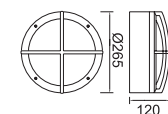

SSK-WSL-C-3108M

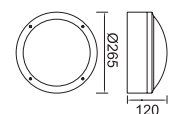

SSK-WSL-C-3109M

- Power: LED 36\*5 (18W)
- Lumens: 1800lm
- Ra: >80
- Working Temp: -10°C TO 50°C
- Beam angle>120°
- CCT: 3000K/6000K
- Fitting Type: Wall, Garden, Burial etc.



- Die-casting aluminum lamp body;
- Opal white PC diffuser;



SSK-WSL-C-3108M-18W



SSK-WSL-C-3109M-18W

# WALL LIGHT



SSK-WSL-C-3106S-3W



SSK-WSL-C-3107S-3W

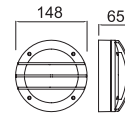

SSK-WSL-C-3106S

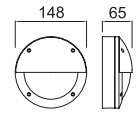

SSK-WSL-C-3107S

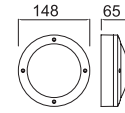

SSK-WSL-C-3108S

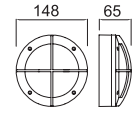

SSK-WSL-C-3109S



SSK-WSL-C-3108S-3W



SSK-WSL-C-3109S-3W

- Power: LED 6\*5 (30W)
- Lumens: 300lm
- Ra: >80
- Working Temp: -10°C TO 50°C
- Beam angle>120°
- CCT: 3000K/6000K
- Fitting Type: Wall, Garden, Burial etc.

- Die-casting aluminum lamp body;
- Opal white PC diffuser;



SSK-WSL-C-3305L-9W



SSK-WSL-C-3306L-9W

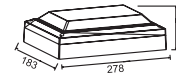

SSK-WSL-C-3305L

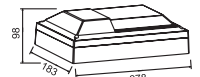

SSK-WSL-C-3306L



SSK-WSL-C-3307L



SSK-WSL-C-3308L

- Power: LED 18\*5 (30W)
- Lumens: 900lm
- Ra: >80
- Working Temp: -10°C TO 50°C
- Beam angle>120°
- CCT: 3000K/6000K
- Fitting Type: Wall, Garden, Burial etc.

- Die-casting aluminum lamp body;
- Opal white PC diffuser;



SSK-WSL-C-3307L-9W



SSK-WSL-C-3308L-9W



**SSK-UDL-01-3055-8W**

## SSK-UDL-01-3055-8W

- Power: LED 8\*1
- Lumens: 800lm
- Ra: >80
- Working Temp: -10°C TO 50°C
- Beam angle >120°
- CCT: 3000K/6000K
- Fitting Type: Wall, Garden, Burial etc.

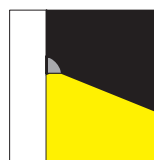
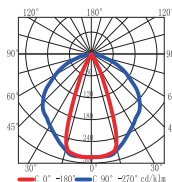
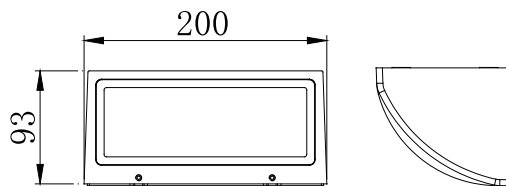

- Die-casting aluminum lamp body;
- Transparent, tempered glass diffuser;
- Silicone rubber gasket;
- Powder coating finish



**SSK-UDL-01-3056-8W**

## SSK-UDL-01-3056-8W

- Power: LED 1\*8
- Lumens: 800lm
- Ra: >80
- Working Temp: -10°C TO 50°C
- Beam angle >120°
- CCT: 3000K/6000K
- Fitting Type: Wall, Garden, Burial etc.

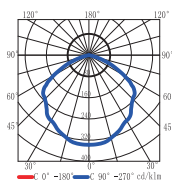
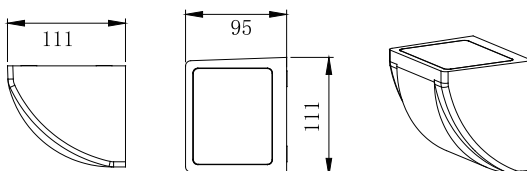

- Die-casting aluminum lamp body;
- Transparent, tempered glass diffuser;
- Silicone rubber gasket;
- Powder coating finish





## SSK-3058-12W

- LED CREE - COB2\*6W
- Lumens: 1200lm
- Ra: >80
- Working Temp: -10°C~50°C
- CCT: 3000K/6000K

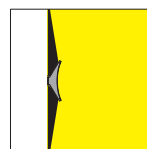
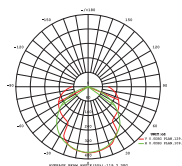
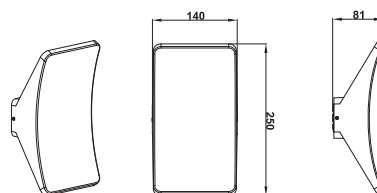

- Die-casting aluminum lamp body;
- Transparent, tempered glass diffuser;
- Silicone rubber gasket;
- Powder coating finish;
- Anodized aluminum reflector

IP 65



## SSK-3067-12W

- LED 1\*12W
- Lumens: 1200lm
- Ra: >80
- Working Temp: -10°C~50°C
- CCT: 3000K/6000K

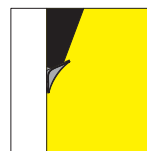
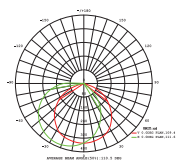
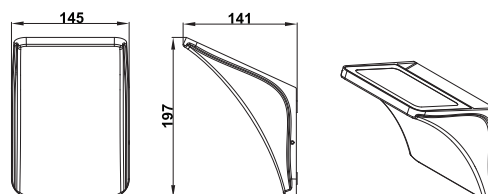

- Die-casting aluminum lamp body;
- Transparent, tempered glass diffuser;
- Silicone rubber gasket;
- Powder coating finish

IP 65





**SSK-3068-6W**

## SSK-3068-6W

- LED 12\*0.5W
- Lumens: 600lm
- Ra: >80
- Working Temp: -10°C~50°C
- CCT: 3000K/6000K

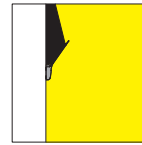
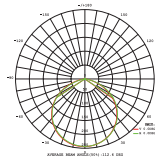
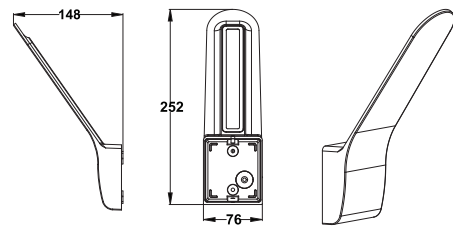

- Die-casting aluminum lamp body;
- Transparent, tempered glass diffuser;
- Silicone rubber gasket;
- Powder coating finish;
- Anodized aluminum reflector

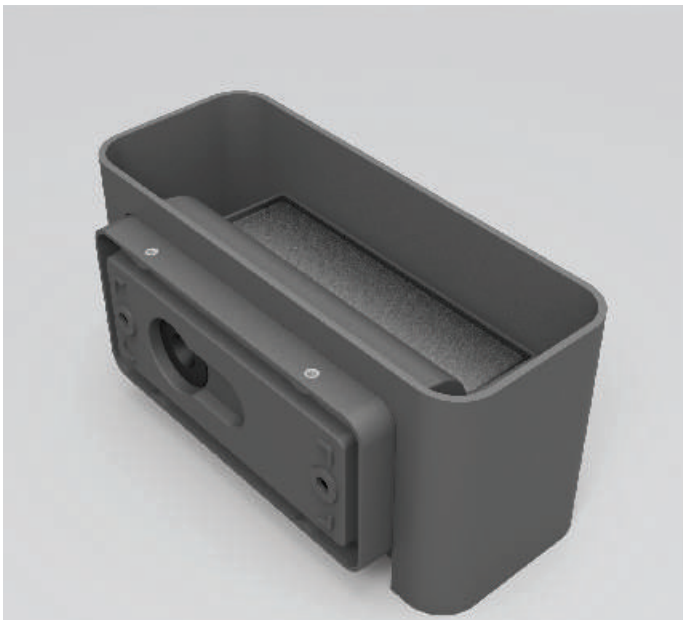

**SSK-013098-10W**

## SSK-013098-10W

- LED 20\*0.5W
- Lumens: 1000lm
- Ra: >80
- Working Temp: -10°C~50°C
- CCT: 3000K/6000K

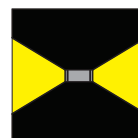
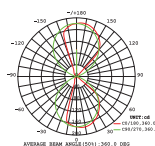
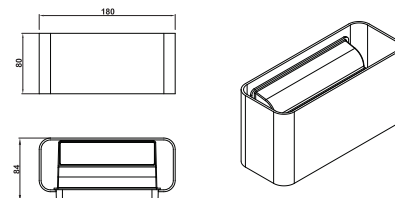

- Die-casting aluminum lamp body;
- Transparent, tempered glass diffuser;
- Silicone rubber gasket;
- Powder coating finish;
- Anodized aluminum reflector





**SSK-UDL-02-3098-10W**

## SSK-UDL-02-3098-10W

- Power: LED 2\*5
- Lumens: 1000lm
- Ra: >80
- Working Temp: -10°C TO 50°C
- Beam angle>120°
- CCT: 3000K/6000K
- Fitting Type: Wall, Garden, Burial etc.

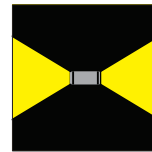
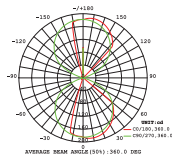
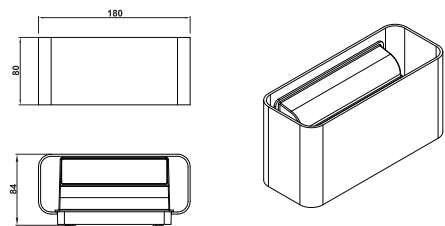

- Die-casting aluminum lamp body;
- Transparent, tempered glass diffuser;
- Silicone rubber gasket;
- Powder coating finish

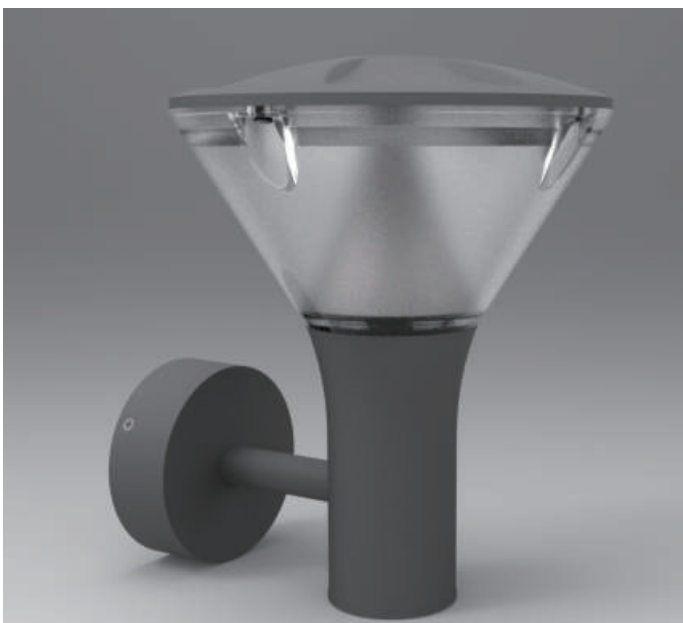

**SSK-UDL-02-03214-SG-8W**

## SSK-UDL-02-03214-SG-8W

- Power: LED COB 16\*0.5W
- Lumens: 800lm
- Ra: >80
- Working Temp: -10°C TO 50°C
- Beam angle>120°
- CCT: 3000K/6000K
- Fitting Type: Wall, Garden, Burial etc.

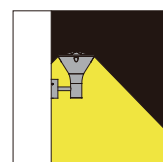
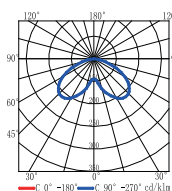
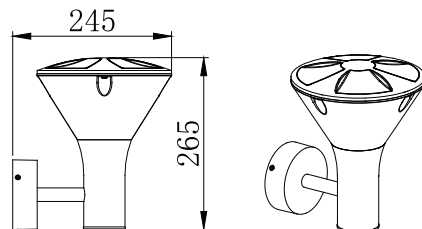

- Die-casting aluminum lamp body;
- Frosted PC diffuser;





SSK-GTL-3662

## SSK-GTL-3662

- Power: LED COB 1\*3
- Lumens: 300lm
- Ra: >80
- Working Temp: -10°C TO 50°C
- Beam angle>120°
- CCT: 3000K/6000K
- Fitting Type: Wall, Garden, Burial etc.

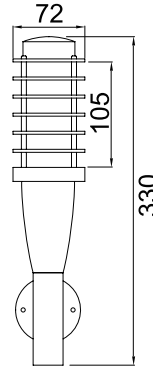

- Die-casting aluminum lamp body;
- Frosted glass diffuser;



SSK-GTL-3664

## SSK-GTL-3664

- Power: LED CREE COB 1\*8
- Lumens: 800lm
- Ra: >80
- Working Temp: -10°C TO 50°C
- Beam angle>120°
- CCT: 3000K/6000K
- Fitting Type: Wall, Garden, Burial etc.

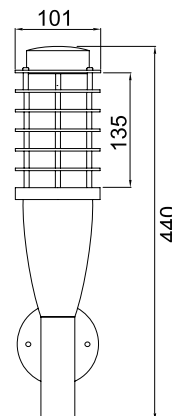

- Die-casting aluminum lamp body;
- Frosted glass diffuser;







**SSK-GTL-025081-30-6W**

## SSK-GTL-025081-30-6W

- Power: LED COB 6\*1
- Lumens: 540lm
- Ra: >80
- PF: 0.085
- Working Temp: -10°C TO 50°C
- Beam angle>120°
- CCT: 3000K/6000K
- Fitting Type: Wall, Garden, Burial etc.

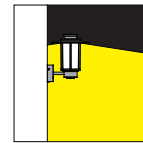
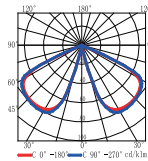
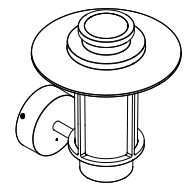
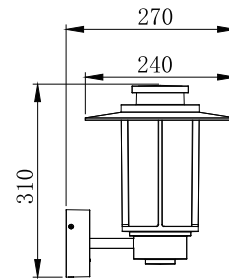

- Die-casting aluminum lamp body;
- Opal PC diffuser;





**SSK-GTL-026081-30-6W**

## SSK-GTL-026081-30-6W

- Power: LED COB 6\*1
- Lumens: 540lm
- Ra: >80
- PF: 0.085
- Working Temp: -10°C TO 50°C
- Beam angle>120°
- CCT: 3000K/6000K
- Fitting Type: Wall, Garden, Burial etc.

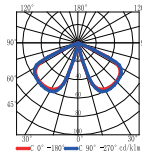
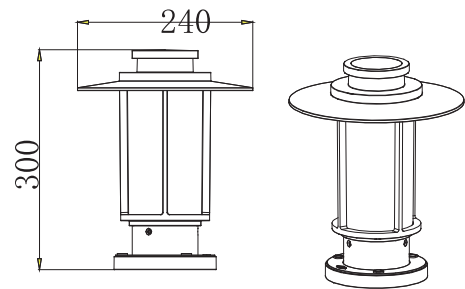

- Die-casting aluminum lamp body;
- Opal PC diffuser;



# STEP LIGHT

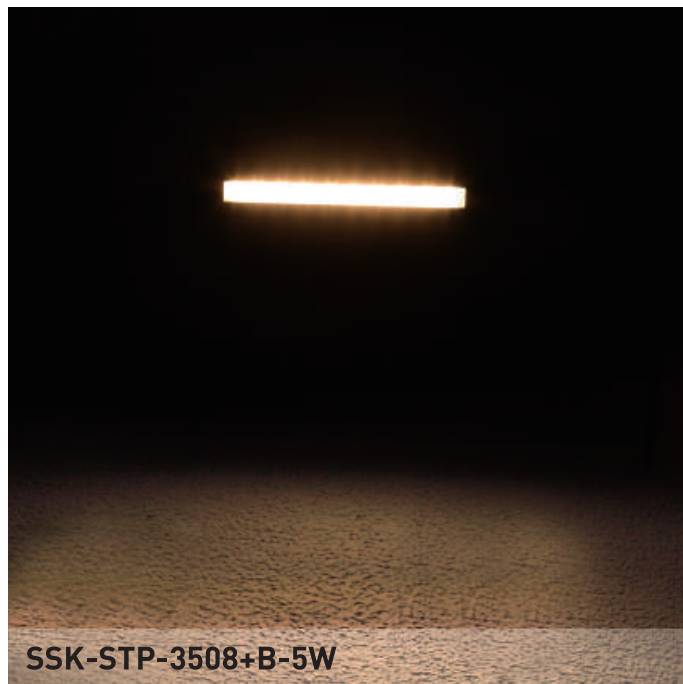

## SSK-STP-3508+B-5W

- Power: LED 10\*0.5W
- Lumens: 500lm
- Ra: >80
- Working Temp: -10°C TO 50°C
- Beam angle>120°
- CCT: 3000K/6000K
- Also Available in green color
- Fitting Type: Wall, Garden, Burial etc.

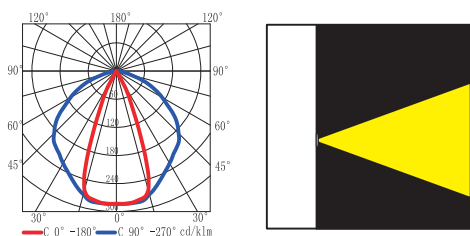
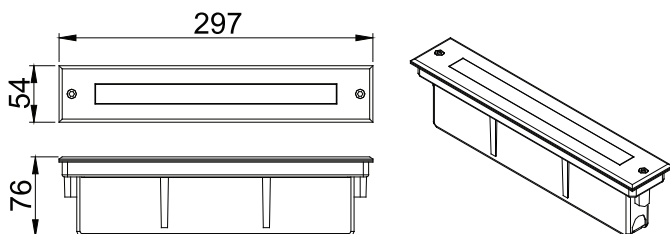

- Die-casting aluminum lamp body;
- Transparent, tempered glass diffuser;
- Silicone rubber gasket;
- Powder coating finish;
- Plastic recessed box





**SSK-STP-083004+B-5W**

## SSK-STP-083004+B-5W

- Power: LED COB 10\*0.5W
- Lumens: 500lm
- Ra: >80
- Working Temp: -10°C TO 50°C
- Beam angle>120°
- CCT: 3000K/6000K
- Fitting Type: Wall, Garden, Burial etc.

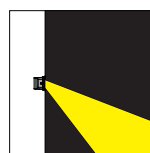
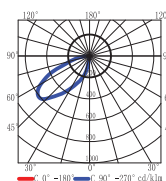
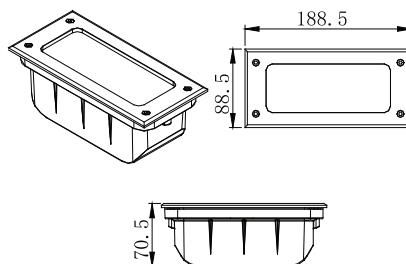

- Die-casting aluminum lamp body;
- 304 stainless steel ring
- Transparent, tempered glass diffuser;
- Silicone rubber gasket;
- Powder coating finish;
- Plastic recessed box

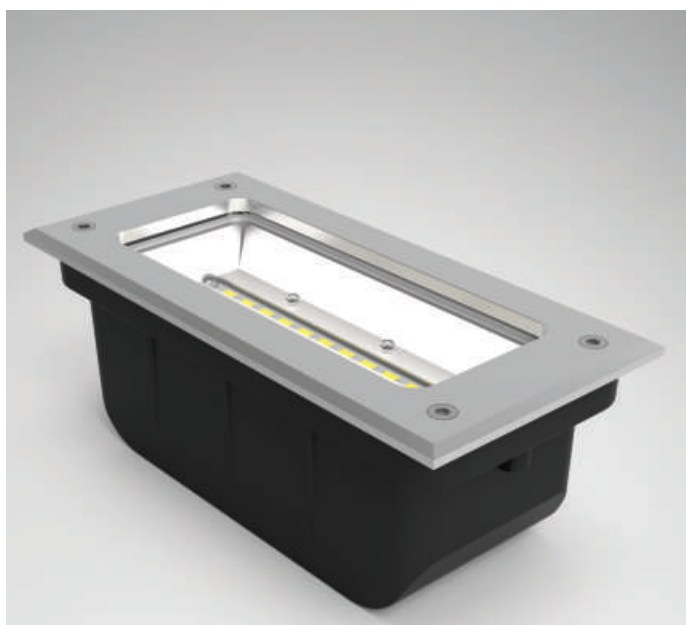

**SSK-STP-093004+B-5W**

## SSK-STP-093004+B-5W

- Power: LED COB 10\*0.5W
- Lumens: 500lm
- Ra: >80
- Working Temp: -10°C TO 50°C
- Beam angle>120°
- CCT: 3000K/6000K
- Fitting Type: Wall, Garden, Burial etc.

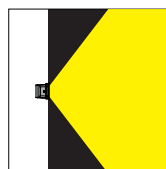
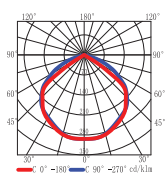
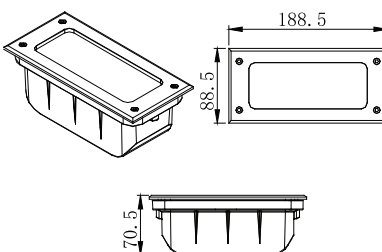

- Die-casting aluminum lamp body;
- 304 stainless steel ring
- Transparent, tempered glass diffuser;
- Silicone rubber gasket;
- Powder coating finish;
- Plastic recessed box





**SSK-STP-10300+B-5W**

## SSK-STP-103004+B-5W

- Power: LED COB 10\*0.5W
- Lumens: 500lm
- Ra: >80
- Working Temp: -10°C TO 50°C
- Beam angle>120°
- CCT: 3000K/6000K
- Fitting Type: Wall, Garden, Burial etc.

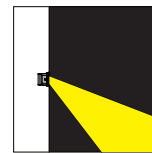
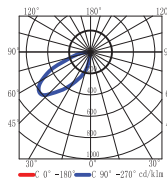
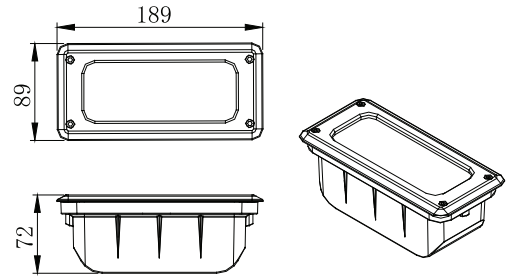

- Die-casting aluminum lamp body;
- Transparent, tempered glass diffuser;
- Silicone rubber gasket;
- Powder coating finish;
- Plastic recessed box

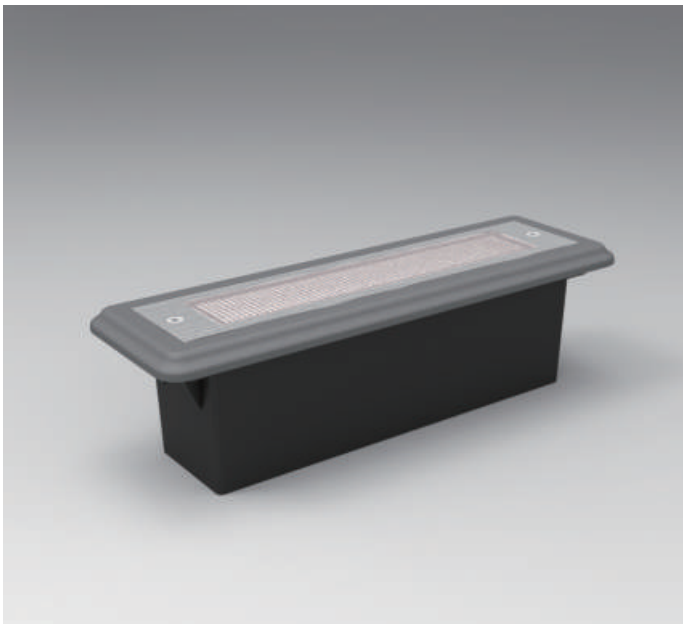

**SSK-STP-3861+B SG-5W**

## SSK-STP-3861+B SG-5W

- Power: LED COB 10\*0.5W
- Lumens: 500lm
- Ra: >80
- Working Temp: -10°C TO 50°C
- Beam angle>120°
- CCT: 3000K/6000K
- Fitting Type: Wall, Garden, Burial etc.

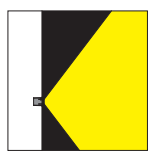
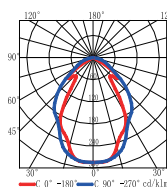
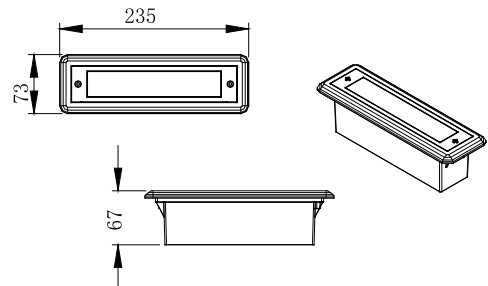

- Die-casting aluminum lamp body;
- Frosted PC diffuser;
- Anti glare, SUS304 ring;
- Silicone rubber gasket;
- Powder coating finish;
- Plastic recessed box





**SSK-TGL-3771DZ-6W**



**SSK-TGL-3772DZ-6W**



**SSK-TGL-3771-6W**



**SSK-TGL-3772-8W**

- Power: LED COB 1\*8W/ LED 6\*1W
- Lumens: 600lm
- Ra: >80
- Working Temp: -10°C TO 50°C
- Beam angle>120°
- CCT: 3000K/6000K
- Also available in green color
- Fitting Type: Wall, Garden, Burial etc.

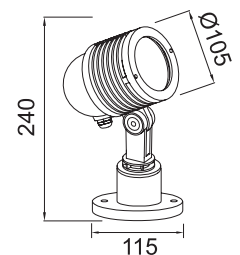
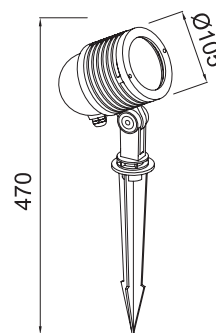

- Die-casting aluminum lamp body;
- Tempered glass diffuser;





SSK-TGL-3741-9W

- Power: LED 9\*1W
- Lumens: 900lm
- Ra: >80
- Working Temp: -10°C TO 50°C
- Beam angle>120°
- CCT: 3000K/6000K
- Fitting Type: Wall, Garden, Burial etc.



SSK-TGL-3743-9W

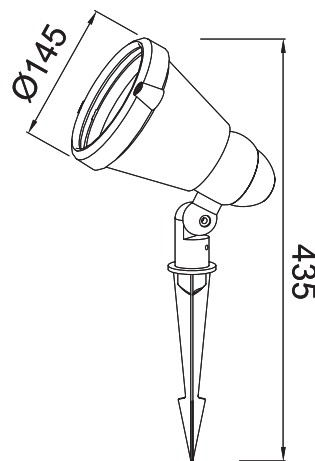

- Die-casting aluminum lamp body;
- Tempered glass diffuser;





- Power: LED 3\*1W
- Lumens: 300lm
- Ra: >80
- Working Temp: -10°C TO 50°C
- Beam angle>120°
- CCT: 3000K/6000K
- Fitting Type: Wall, Garden, Burial etc.



SSK-TGL-3717



SSK-TGL-3718

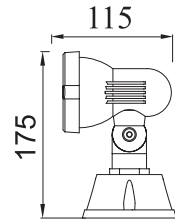
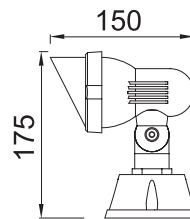

- Die-casting aluminum lamp body;
- Transparent, tempered glass diffuser;



- Power: LED 3\*1W
- Lumens: 300lm
- Ra: >80
- Working Temp: -10°C TO 50°C
- Beam angle>120°
- CCT: 3000K/6000K
- Fitting Type: Wall, Garden, Burial etc.



SSK-TGL-3713-3W



SSK-TGL-3714-3W

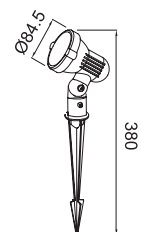
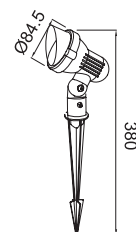

- Die-casting aluminum lamp body;
- Transparent, tempered glass diffuser;







## SSK-TGL-3613

- Power: LED 3\*1W
- Lumens: 300lm
- Ra: >80
- Working Temp: -10°C TO 50°C
- Beam angle>120°
- CCT: 3000K/6000K
- Fitting Type: Wall, Garden, Burial etc.

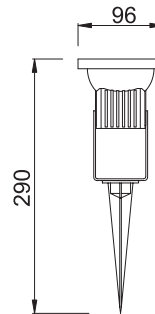

- Die-casting aluminum lamp body;
- Transparent, tempered glass diffuser;



## SSK-TGL-3791

- Power: LED 5\*1W
- Lumens: 500lm
- Ra: >80
- Working Temp: -10°C TO 50°C
- Beam angle>120°
- CCT: 3000K/6000K
- Fitting Type: Wall, Garden, Burial etc.

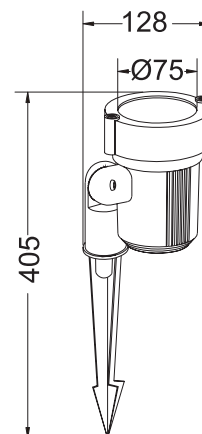

- Die-casting aluminum lamp body;
- Transparent, tempered glass diffuser;





## SSK-TGL-043743

- Power: LED 1\*15W
- Lumens: 1500lm
- Ra: >80
- Working Temp: -10°C TO 50°C
- Beam angle>120°
- CCT: 3000K/6000K
- Fitting Type: Wall, Garden, Burial etc.

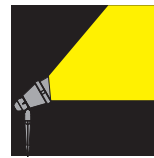
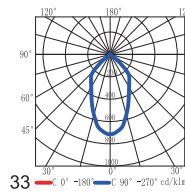
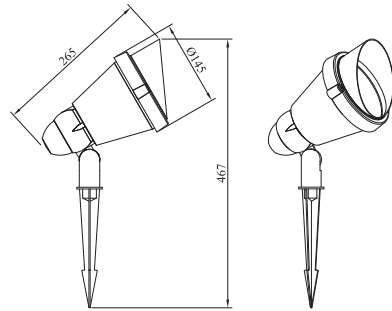

- Die-casting aluminum lamp body;
- Transparent, tempered glass diffuser;
- Silicone rubber gasket;
- Powder coating finish;



SSK-TGL- 3005



## SSK-TGL-3005

- Power: LED 1\*12W
- Lumens: 1200lm
- Ra: >80
- Working Temp: -10°C TO 50°C
- Beam angle>120°
- CCT: 3000K/6000K
- Fitting Type: Wall, Garden, Burial etc.

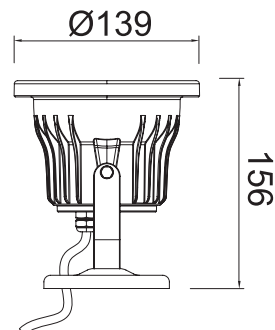

- Die-casting aluminum lamp body;
- Transparent, tempered glass diffuser;



SSK-TGL- 3005



SSK-TGL-013541

## SSK-TGL-013541

- Power: LED 16\*1W
- Lumens: 1600lm
- Ra: >80
- Working Temp: -10°C TO 50°C
- Beam angle>120°
- CCT: 3000K/6000K
- Fitting Type: Wall, Garden, Burial etc.

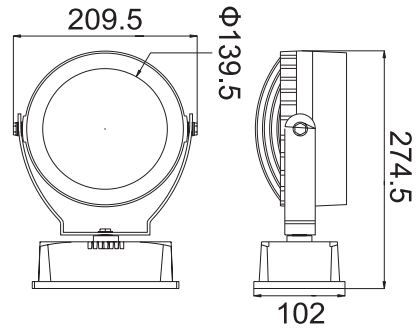

- Die-casting aluminum lamp body;
- Transparent, tempered glass diffuser;



SSK-TGL-013543

## SSK-TGL-013543

- Power: LED 16\*1W
- Lumens: 1600lm
- Ra: >80
- Working Temp: -10°C TO 50°C
- Beam angle>120°
- CCT: 3000K/6000K
- Fitting Type: Wall, Garden, Burial etc.

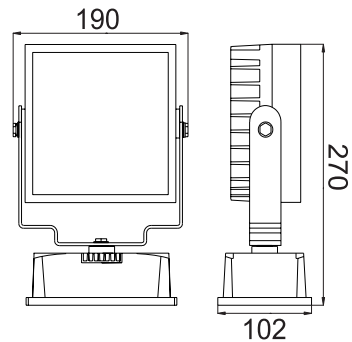

- Die-casting aluminum lamp body;
- Transparent, tempered glass diffuser;



# BOLLARD LIGHT (MINI)



SSK-BRD-29-3275

## SSK-BRD-29-3275

- Power: LED 1\*12W
- Lumens: 1200lm
- Ra: >80
- Working Temp: -10°C TO 50°C
- Beam angle>120°
- CCT: 3000K/6000K
- Fitting Type: Wall, Garden, Burial etc.

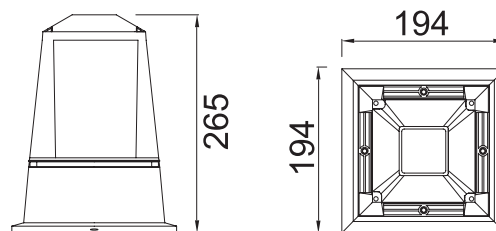

- Die-casting aluminum lamp body;
- Clear PC diffuser;



SSK-BRD-29-3274

## SSK-BRD-23-3274

- Power: LED COB CREE 1\*12W
- Lumens: 1200lm
- Ra: >80
- Working Temp: -10°C TO 50°C
- Beam angle>120°
- CCT: 3000K/6000K
- Fitting Type: Wall, Garden, Burial etc.

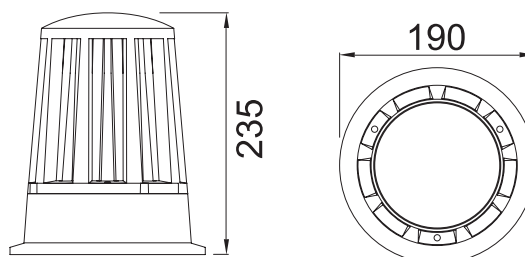

- Die-casting aluminum lamp body;
- Clear PC diffuser;





## SSK-BRD-60-3164

- Power: LED 1\*8W
- Lumens: 800lm
- Ra: >80
- Working Temp: -10°C TO 50°C
- Beam angle>120°
- CCT: 3000K/6000K
- Fitting Type: Wall, Garden, Burial etc.

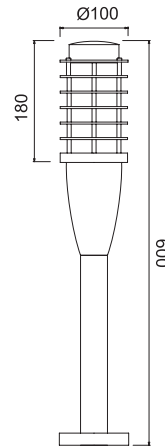

- Die-casting aluminum lamp body;
- Frosted glass diffuser;



SSK-BRD-60-3164



## SSK-BRD-80-003235-8W

- Power: LED 16\*0.5W
- Lumens: 800lm
- Ra: >80
- Working Temp: -10°C TO 50°C
- Beam angle>120°
- CCT: 3000K/6000K
- Fitting Type: Wall, Garden, Burial etc.

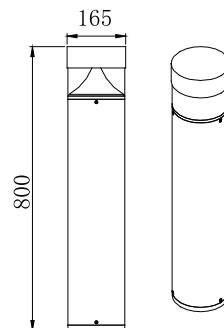

- Die-casting aluminum lamp body;
- Clear PC diffuser;



SSK-BRD-80-003235-8W

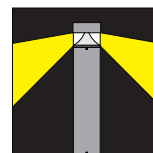
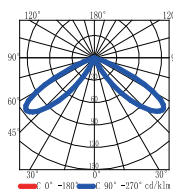



## SSK-BRD-80-013214-8W

- Power: LED COB 16\*0.5W
- Lumens: 800lm
- Ra: >80
- PF:0.85
- Working Temp: -10°C TO 50°C
- Beam angle>120°
- CCT: 3000K/6000K
- Fitting Type: Wall, Garden, Burial etc.

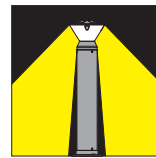
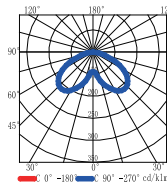
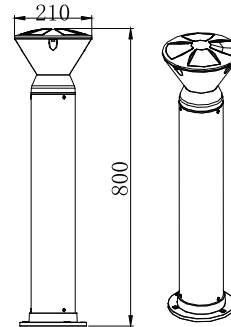

- Die-casting aluminum lamp body;
- Frosted PC diffuser;



## SSK-BRD-30-013214-8W

- Power: LED COB 16\*0.5W
- Lumens: 800lm
- Ra: >80
- PF:0.85
- Working Temp: -10°C TO 50°C
- Beam angle>120°
- CCT: 3000K/6000K
- Fitting Type: Wall, Garden, Burial etc.

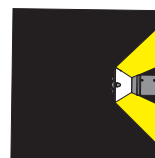
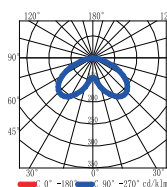
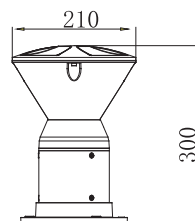

- Die-casting aluminum lamp body;
- Frosted PC diffuser;





## SSK-BRD-80-023214-8W

- Power: LED COB 16\*0.5W
- Lumens: 800lm
- Ra: >80
- PF:0.85
- Working Temp: -10°C TO 50°C
- Beam angle>120°
- CCT: 3000K/6000K
- Fitting Type: Wall, Garden, Burial etc.

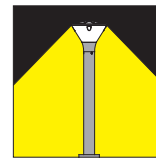
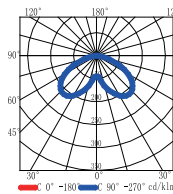
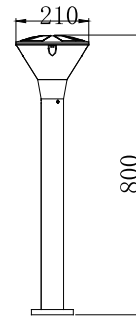

- Die-casting aluminum lamp body;
- Frosted PC diffuser;



## SSK-BRD-30-023214-8W

- Power: LED COB 16\*0.5W
- Lumens: 800lm
- Ra: >80
- PF:0.85
- Working Temp: -10°C TO 50°C
- Beam angle>120°
- CCT: 3000K/6000K
- Fitting Type: Wall, Garden, Burial etc.

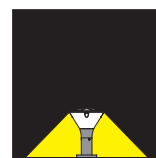
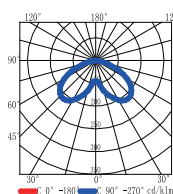
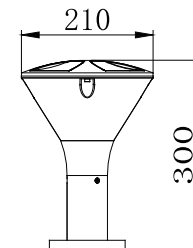

- Die-casting aluminum lamp body;
- Frosted PC diffuser;





## SSK-BRD-60-023103RH-8W

- Power: LED CREE COB 1\*8W
- Lumens: 760lm
- Ra: >80
- PF:0.85
- Working Temp: -10°C TO 50°C
- Beam angle>120°
- CCT: 3000K/6000K
- Fitting Type: Wall, Garden, Burial etc.

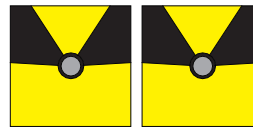
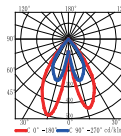
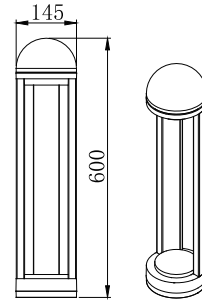

- Die-casting aluminum lamp body;
- Tempered glass diffuser;



## SSK-BRD-45-053214-8W

- Power: LED CREE COB 16\*0.5W
- Lumens: 800lm
- Ra: >80
- PF:0.85
- Working Temp: -10°C TO 50°C
- Beam angle>120°
- CCT: 3000K/6000K
- Fitting Type: Wall, Garden, Burial etc.

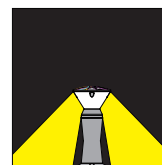
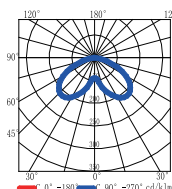
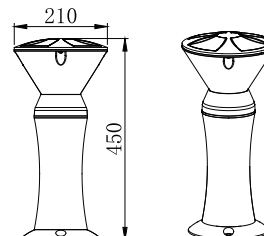

- Die-casting aluminum lamp body;
- Frosted PC diffuser;





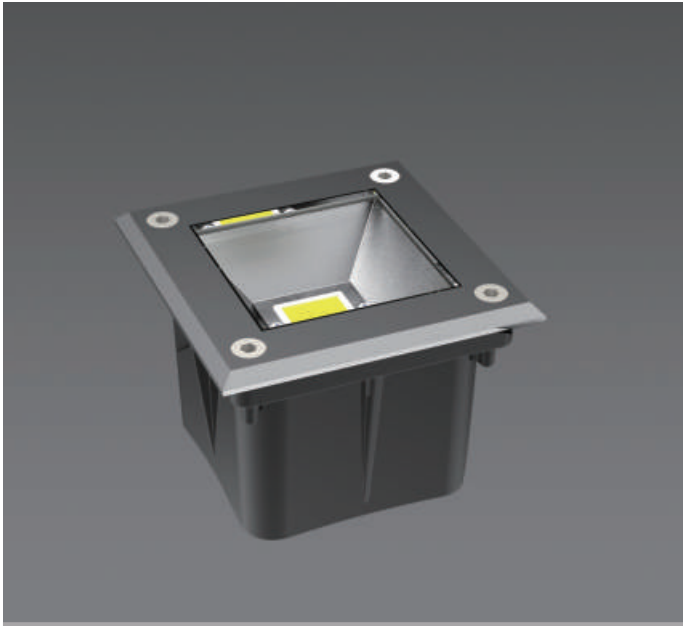

**SSK-BGL-S-3670-5W**

## SSK-BGL-S-3670-5W

- Power: LED 1\*5W
- Lumens: 500lm
- Ra: >80
- Working Temp: -10°C TO 50°C
- Beam angle>120°
- CCT: 3000K/6000K
- Fitting Type: Wall, Garden, Burial etc.

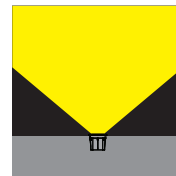
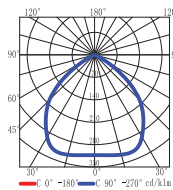
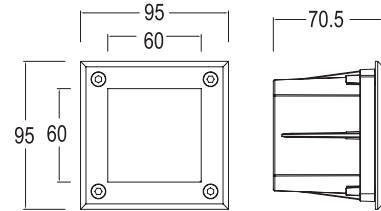

- Die-casting aluminum lamp body;
- Transparent, tempered glass diffuser;
- 304 stainless steel ring;

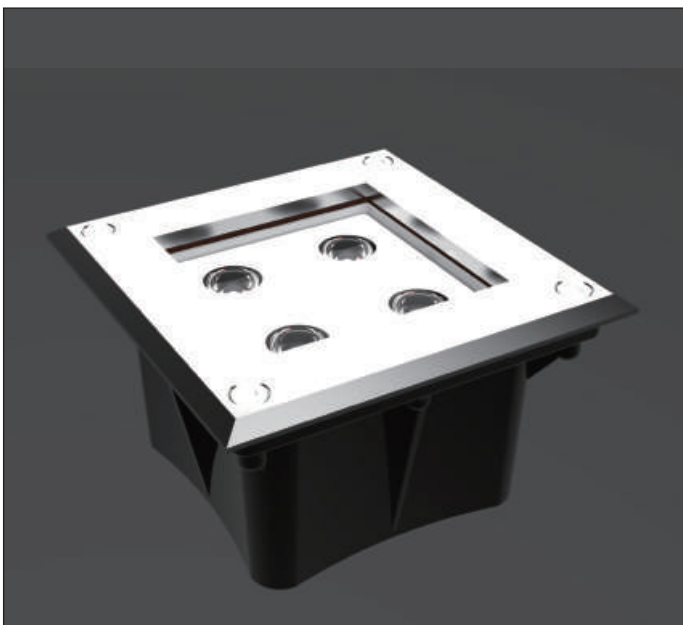

**SSK-BGL-S-3671-4W**

## SSK-BGL-S-3671-4W

- Power: LED 4\*1W
- Lumens: 400lm
- Ra: >80
- Working Temp: -10°C TO 50°C
- Beam angle>120°
- CCT: 3000K/6000K
- Fitting Type: Wall, Garden, Burial etc.

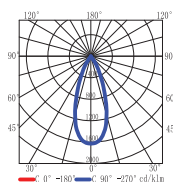
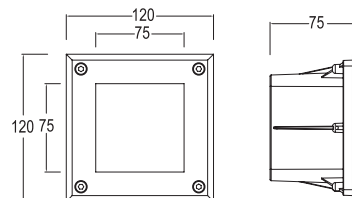

- Die-casting aluminum lamp body;
- 304 stainless steel ring
- Transparent, tempered glass diffuser;
- Silicone rubber gasket;
- Powder coating finish;
- Plastic recessed box



# BURIAL LIGHT



## SSK-BGL-S-3672-9W

- Power: LED 9\*1W
- Lumens: 900lm
- Ra: >80
- Working Temp: -10°C TO 50°C
- Beam angle>120°
- CCT: 3000K/6000K
- Fitting Type: Wall, Garden, Burial etc.

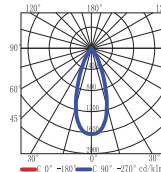
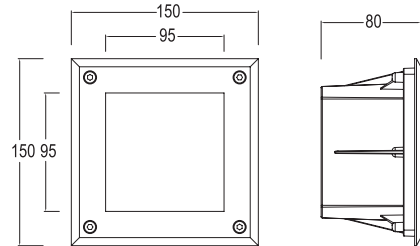

- Die-casting aluminum lamp body;
- Transparent, tempered glass diffuser;
- 304 stainless steel ring;



## SSK-BGL-S-3673-16W

- Power: LED 16\*1W
- Lumens: 1600lm
- Ra: >80
- Working Temp: -10°C TO 50°C
- Beam angle>120°
- CCT: 3000K/6000K
- Fitting Type: Wall, Garden, Burial etc.

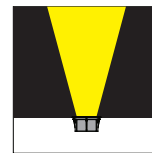
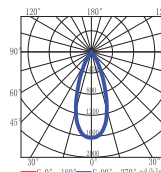
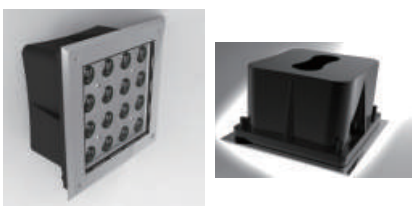
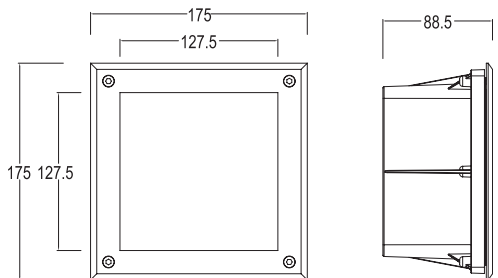

- Die-casting aluminum lamp body;
- Transparent, tempered glass diffuser;
- 304 stainless steel ring;



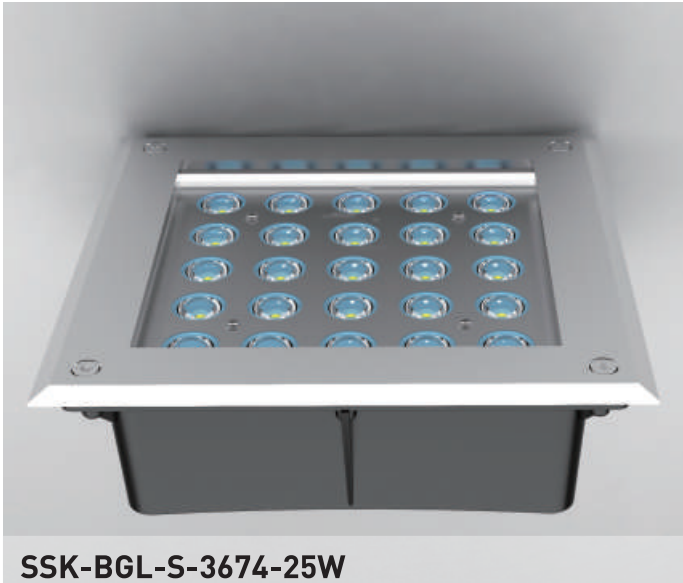

## SSK-BGL-S-3674-25W

- Power: LED 25\*1W
- Lumens: 2500lm
- Ra: >80
- Working Temp: -10°C TO 50°C
- Beam angle>120°
- CCT: 3000K/6000K
- Fitting Type: Wall, Garden, Burial etc.

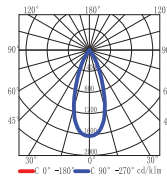
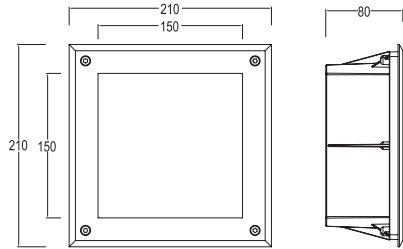

- Die-casting aluminum lamp body;
- Transparent, tempered glass diffuser;
- 304 stainless steel ring;



## SSK-BGL-S-3583+B-6W

- Power: LED 6\*1W
- Lumens: 600lm
- Ra: >80
- Working Temp: -10°C TO 50°C
- Beam angle>120°
- CCT: 3000K/6000K
- Fitting Type: Wall, Garden, Burial etc.

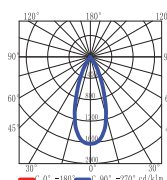
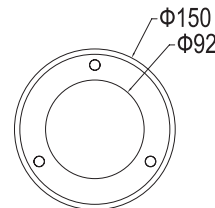

- Die-casting aluminum lamp body;
- 304 stainless steel ring
- Transparent, tempered glass diffuser;
- Silicone rubber gasket;
- Powder coating finish;
- Plastic recessed box





## SSK-BGL-R-3521+B-10W

- Power: LED 10\*1W
- Lumens: 1000lm
- Ra: >80
- Working Temp: -10°C TO 50°C
- Beam angle>120°
- CCT: 3000K/6000K
- Fitting Type: Wall, Garden, Burial etc.

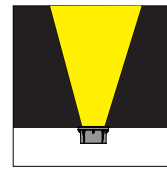
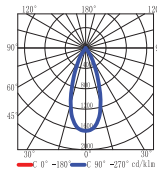
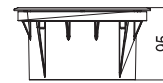
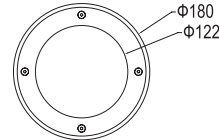

- Die-casting aluminum lamp body;
- 304 stainless steel ring
- Transparent, tempered glass diffuser;
- Silicone rubber gasket;
- Powder coating finish;
- Plastic recessed box



## SSK-BGL-R-3581+B-15W

- Power: LED 15\*1W
- Lumens: 1500lm
- Ra: >80
- Working Temp: -10°C TO 50°C
- Beam angle>120°
- CCT: 3000K/6000K
- Fitting Type: Wall, Garden, Burial etc.

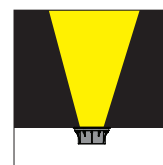
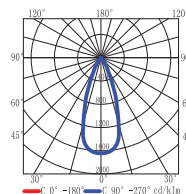
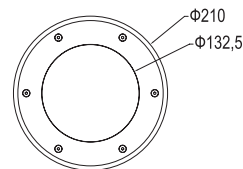

- Die-casting aluminum lamp body;
- 304 stainless steel ring
- Transparent, tempered glass diffuser;
- Silicone rubber gasket;
- Powder coating finish;
- Plastic recessed box



# BURIAL LIGHT



## SSK-BGL-R-3591+B-25W

- Power: LED 25\*1W
- Lumens: 2500lm
- Ra: >80
- Working Temp: -10°C TO 50°C
- Beam angle>120°
- CCT: 3000K/6000K
- Fitting Type: Wall, Garden, Burial etc.

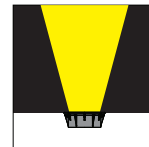
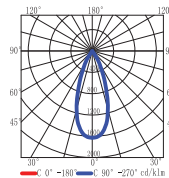
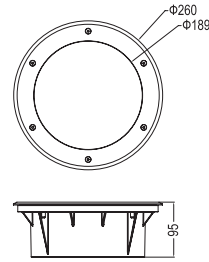

- Die-casting aluminum lamp body;
- Transparent, tempered glass diffuser;
- 304 stainless steel ring;



## SSK-BGL-R-3002+B

- Power: LED CREE COB 1\*12W
- Lumens: 1200lm
- Ra: >80
- Working Temp: -10°C TO 50°C
- Beam angle>120°
- CCT: 3000K/6000K
- Fitting Type: Wall, Garden, Burial etc.

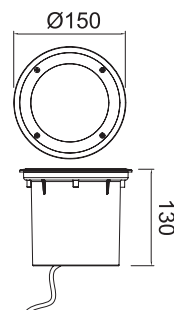

- Die-casting aluminum lamp body;
- Transparent, tempered glass diffuser;





SSK-BGL-R-3575+B-3W



## SSK-BGL-R-3575+B-3W

- Power: LED 3\*1W
- Lumens: 300lm
- Ra: >80
- Working Temp: -10°C TO 50°C
- Beam angle>120°
- CCT: 3000K/6000K
- Fitting Type: Wall, Garden, Burial etc.

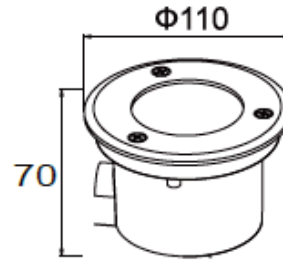

- Die-casting aluminum lamp body;
- Transparent, tempered glass diffuser;



SSK-BGL-R-3642+B-1W

## SSK-BGL-R-3642+B-1W

- Power: LED 1\*1W
- Lumens: 100lm
- Ra: >80
- Working Temp: -10°C TO 50°C
- Beam angle>120°
- CCT: 3000K/6000K
- Fitting Type: Wall, Garden, Burial etc.

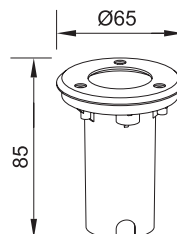

- 304 stainless steel lamp body & cover;
- Transparent, tempered glass diffuser;





**SSK-BGL-023705+B-2W**

## SSK-BGL-023705+B-2W

- Power: LED 1\*2W
- Lumens: 200lm
- Ra: >80
- PF:0.85
- Working Temp: -10°C TO 50°C
- Beam angle>120°
- CCT: 3000K/6000K
- Fitting Type: Wall, Garden, Burial etc.

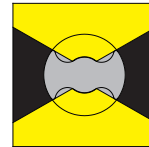
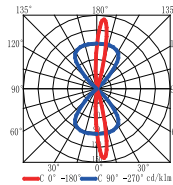
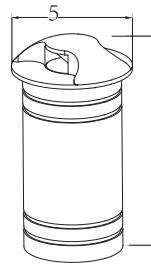

- Die-casting aluminum lamp body;
- Clear glass diffuser;
- Silicone rubber gasket;
- Oxide coating finish

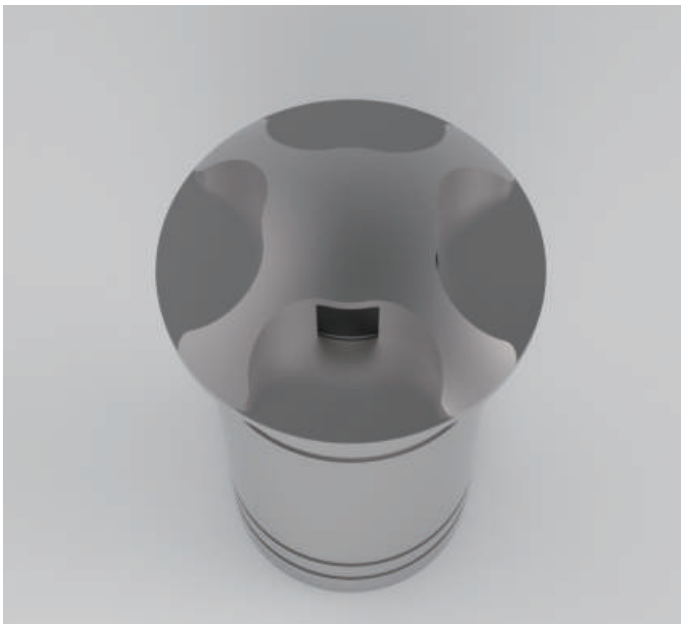

**SSK-BGL-043705+B-2W**

## SSK-BGL-043705+B-2W

- Power: LED 1\*2W
- Lumens: 200lm
- Ra: >80
- PF:0.85
- Working Temp: -10°C TO 50°C
- Beam angle>120°
- CCT: 3000K/6000K
- Fitting Type: Wall, Garden, Burial etc.

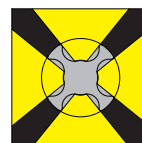
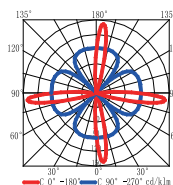
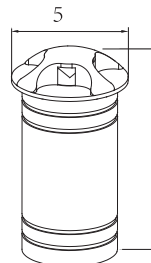

- Die-casting aluminum lamp body;
- Clear glass diffuser;
- Silicone rubber gasket;
- Oxide coating finish





## SSK-BGL-R-003702+B-2W

- Power: LED 1\*2W
- Lumens: 200lm
- Ra: >80
- PF:0.85
- Working Temp: -10°C TO 50°C
- Beam angle>120°
- CCT: 3000K/6000K
- Fitting Type: Wall, Garden, Burial etc.

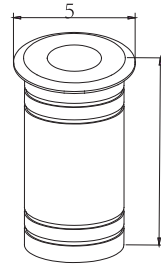

SSK-BGL-R-003702+B

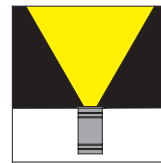
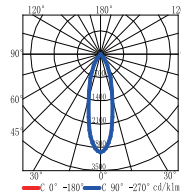

- Die-casting aluminum lamp body;
- Clear glass diffuser;
- Silicone rubber gasket;
- Oxide coating finish





# FOUNTAIN LIGHT



SSK-3633-8W

## SSK-FTL-3633-8W

- Power: LED 8\*1W
- Lumens: 800lm
- Ra: >80
- Working Temp: -10°C TO 50°C
- Beam angle >120°
- CCT: 3000K/6000K
- Fitting Type: Wall, Garden, Burial etc.

## SSK-FTL-3633-3W RGB

- LED 9\*1W
- Lumens: 900lm

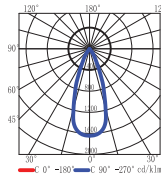
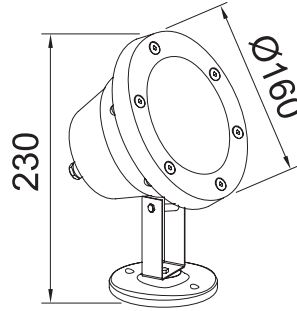

- Stainless steel body;
- Transparent, tempered glass diffuser;
- Silicone gasket;



Note: All the lights need waterproof step down transformers, input voltage = 12V AC



SSK-3601-3W

## SSK-FTL-3601-8W

- Power: LED 3\*1W
- Lumens: 300lm
- Ra: >80
- Working Temp: -10°C TO 50°C
- Beam angle >120°
- CCT: 3000K/6000K
- Fitting Type: Wall, Garden, Burial etc.

## SSK-FTL-3601-3W RGB

- LED 3\*1W
- Lumens: 300lm

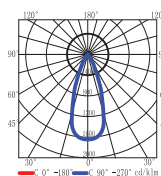
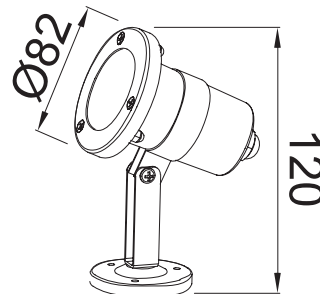

- Stainless steel body;
- Transparent, tempered glass diffuser;
- Silicone gasket;



Note: All the lights need waterproof step down transformers, input voltage = 12V AC





## SSK-FTL-3603S-3W

- Power: LED 3\*1W
- Lumens: 300lm
- Ra: >80
- Working Temp: -10°C TO 50°C
- Beam angle >120°
- CCT: 3000K/6000K
- Fitting Type: Wall, Garden, Burial etc.

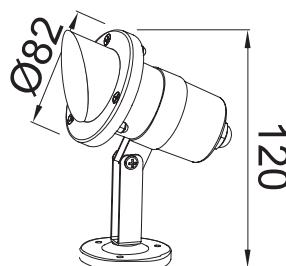

- Stainless steel body;
- Transparent, tempered glass diffuser;
- Silicone gasket;



Note: All the lights need waterproof step down transformers, input voltage = 12V AC

## ARCHITECTURAL LIGHTING



 Shri Swaminarayan Mandir, Pune



RGB Flood Light

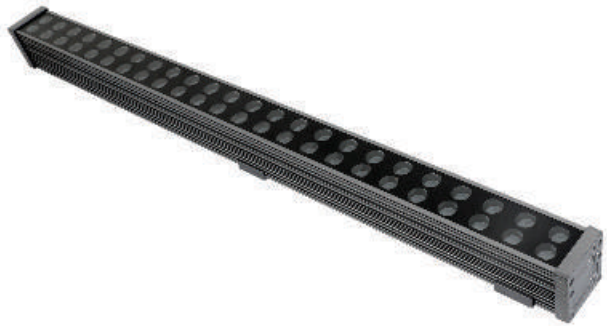

Linear Light



 Alipore Bridge, Bhawanipur, Kolkata

LED Architectural facade lighting is fast becoming the must-have technology to illuminate the exteriors and draw attention to the facades.

SYSKA offers a wide range of RGB/ RGBW LED flood lights/linear lights to illuminate the exteriors of heritage monuments, buildings, railway stations, temples, bridges etc.



SYSKA LED Lights Pvt. Ltd.

Corp. Office: Syska House, Plot No. - 89/90/91, Survey No. - 232/1/2, Off VIP Airport Road,

Lane No. - 4, Sakore Nagar, Lohegaon, Pune - 411014 | Toll Free: 1800 102 8787

Email: [customercare.led@sskgroup.in](mailto:customercare.led@sskgroup.in) | [www.syska.co.in](http://www.syska.co.in)

Disclaimer: • Specifications mentioned are based on test reports at the time of preparation of this catalogue. • Technical products are under continuous upgradation & specifications may vary 5-10% depending on testing standards/instruments. • Value parameters are approximate. • Images are for reference purpose, drawn from photographs & rendering. Actual products may vary in appearance. • Product applications are mentioned specifically for indoor/outdoor use. • Lumens mentioned are for higher CCT (6500K/5000K), for lower CCT (4000K/3000K), lumens reduce at 10-15%. • In case, IP rating is not specified, it should be considered as IP65.